

§ 170.11

14 CFR Ch. I (1–1–24 Edition)

observed air traffic which may be in such proximity to the position or intended route of flight of their aircraft to warrant attention.

Traffic pattern means the flow of aircraft operating on and in the vicinity of an airport during specified wind conditions as established by appropriate authority.

VFR traffic means aircraft operated solely in accordance with Visual Flight Rules.

Visual flight rules (VFR) means rules that govern the procedures for conducting flight under visual conditions. The term “VFR” is also used in the United States to indicate weather conditions that are equal to or greater than minimum VFR requirements. In addition, “VFR” is used by pilots and controllers to indicate the type of flight plan.

Visual meteorological conditions (VMC) means meteorological conditions expressed in terms of visibility, distance from clouds, and ceiling equal to or better than specified minima.

[56 FR 341, Jan. 3, 1991, as amended by Amdt. 170–3, 66 FR 21067, Apr. 27, 2001; Docket FAA–2017–0733, Amdt. 170–4, 82 FR 34400, July 25, 2017]

Subpart B—Airport Traffic Control Towers

§ 170.11 Scope.

This subpart sets forth establishment and discontinuance criteria for Airport Traffic Control Towers.

§ 170.13 Airport Traffic Control Tower (ATCT) establishment criteria.

(a) The following criteria along with general facility establishment standards must be met before an airport can qualify for an ATCT:

(1) The airport, whether publicly or privately owned, must be open to and available for use by the public as defined in the Airport and Airway Improvement Act of 1982;

(2) The airport must be recognized by and contained within the National Plan of Integrated Airport Systems;

(3) The airport owners/authorities must have entered into appropriate assurances and covenants to guarantee that the airport will continue in operation for a long enough period to per-

mit the amortization of the ATCT investment;

(4) The FAA must be furnished appropriate land without cost for construction of the ATCT; and

(5) The airport must meet the benefit-cost ratio criteria specified herein utilizing three consecutive FAA annual counts and projections of future traffic during the expected life of the tower facility. (An FAA annual count is a fiscal year or a calendar year activity summary. Where actual traffic counts are unavailable or not recorded, adequately documented FAA estimates of the scheduled and nonscheduled activity may be used.)

(b) An airport meets the establishment criteria when it satisfies paragraphs (a)(1) through (a)(5) of this section and its benefit-cost ratio equals or exceeds one. As defined in §170.3 of this part, the benefit-cost ratio is the ratio of the present value of the ATCT life cycle benefits (BPV) to the present value of ATCT life cycle costs (CPV).

BPV/CPV≥1.0

(c) The satisfaction of all the criteria listed in this section does not guarantee that the airport will receive an ATCT.

§ 170.15 ATCT discontinuance criteria.

An ATCT will be subject to discontinuance when the continued operation and maintenance costs less termination costs (CMPV) of the ATCT exceed the present value of its remaining life-cycle benefits (BPV):

BPV/CMPV<1.0

Subpart C [Reserved]

PART 171—NON-FEDERAL NAVIGATION FACILITIES

Subpart A—VOR Facilities

- Sec.
- 171.1 Scope.
- 171.3 Requests for IFR procedure.
- 171.5 Minimum requirements for approval.
- 171.7 Performance requirements.
- 171.9 Installation requirements.
- 171.11 Maintenance and operations requirements.
- 171.13 Reports.

Federal Aviation Administration, DOT

§ 171.1

Subpart B—Nondirectional Radio Beacon Facilities

- 171.21 Scope.
- 171.23 Requests for IFR procedure.
- 171.25 Minimum requirements for approval.
- 171.27 Performance requirements.
- 171.29 Installation requirements.
- 171.31 Maintenance and operations requirements.
- 171.33 Reports.

Subpart C—Instrument Landing System (ILS) Facilities

- 171.41 Scope.
- 171.43 Requests for IFR procedure.
- 171.45 Minimum requirements for approval.
- 171.47 Performance requirements.
- 171.49 Installation requirements.
- 171.51 Maintenance and operations requirements.
- 171.53 Reports.

Subpart D—True Lights

- 171.61 Air navigation certificate: Revocation and termination.

Subpart E—General

- 171.71 Materials incorporated by reference.
- 171.73 Alternative forms of reports.
- 171.75 Submission of requests.

Subpart F—Simplified Directional Facility (SDF)

- 171.101 Scope.
- 171.103 Requests for IFR procedure.
- 171.105 Minimum requirements for approval.
- 171.107 Definition.
- 171.109 Performance requirements.
- 171.111 Ground standards and tolerances.
- 171.113 Installation requirements.
- 171.115 Maintenance and operations requirements.
- 171.117 Reports.

Subpart G—Distance Measuring Equipment (DME)

- 171.151 Scope.
- 171.153 Requests for IFR procedure.
- 171.155 Minimum requirements for approval.
- 171.157 Performance requirements.
- 171.159 Installation requirements.
- 171.161 Maintenance and operations requirements.
- 171.163 Reports.

Subpart H—VHF Marker Beacons

- 171.201 Scope.
- 171.203 Requests for IFR procedure.
- 171.205 Minimum requirements for approval.
- 171.207 Performance requirements.
- 171.209 Installation requirements.

- 171.211 Maintenance and operations requirements.
- 171.213 Reports.

Subpart I—Interim Standard Microwave Landing System (ISMLS)

- 171.251 Scope.
- 171.253 Definitions.
- 171.255 Requests for IFR procedures.
- 171.257 Minimum requirements for approval.
- 171.259 Performance requirements: General.
- 171.261 Localizer performance requirements.
- 171.263 Localizer automatic monitor system.
- 171.265 Glide path performance requirements.
- 171.267 Glide path automatic monitor system.
- 171.269 Marker beacon performance requirements.
- 171.271 Installation requirements.
- 171.273 Maintenance and operations requirements.
- 171.275 Reports.

Subpart J—Microwave Landing System (MLS)

- 171.301 Scope.
- 171.303 Definitions.
- 171.305 Requests for IFR procedure.
- 171.307 Minimum requirements for approval.
- 171.309 General requirements.
- 171.311 Signal format requirements.
- 171.313 Azimuth performance requirements.
- 171.315 Azimuth monitor system requirements.
- 171.317 Approach elevation performance requirements.
- 171.319 Approach elevation monitor system requirements.
- 171.321 DME and marker beacon performance requirements.
- 171.323 Fabrication and installation requirements.
- 171.325 Maintenance and operations requirements.
- 171.327 Operational records.

AUTHORITY: 49 U.S.C. 106(g), 40103–40107, 40109, 40113, 44502, 44701–44702, 44708–44709, 44711, 44719–44721, 45303, 46308.

SOURCE: Docket No. 5034, 29 FR 11337, Aug. 6, 1964, unless otherwise noted.

Subpart A—VOR Facilities

§ 171.1 Scope.

This subpart sets forth minimum requirements for the approval and operation on non-Federal VOR facilities that are to be involved in the approval

§ 171.3

14 CFR Ch. I (1–1–24 Edition)

of instrument flight rules and air traffic control procedures related to those facilities.

[Doc. No. 5034, 29 FR 11337, Aug. 6, 1964, as amended by Amdt. 171–2, 31 FR 5408, Apr. 6, 1966; Amdt. 171–7, 35 FR 12711, Aug. 11, 1970]

§ 171.3 Requests for IFR procedure.

(a) Each person who requests an IFR procedure based on a VOR facility that he owns must submit the following information with that request:

(1) A description of the facility and evidence that the equipment meets the performance requirements of § 171.7 and is installed in accordance with § 171.9.

(2) A proposed procedure for operating the facility.

(3) A proposed maintenance organization and maintenance manual that meets the requirements of § 171.11.

(4) A statement of intention to meet the requirements of this subpart.

(5) A showing that the facility has an acceptable level of operational reliability and an acceptable standard of performance. Previous equivalent operational experience with a facility with identical design and operational characteristics will be considered in showing compliance with this paragraph.

(b) After the FAA inspects and evaluates the facility, it advises the owner of the results and of any required changes in the facility or the maintenance manual or maintenance organization. The owner must then correct the deficiencies, if any, and operate the facility for an in-service evaluation by the FAA.

[Doc. No. 5034, 29 FR 11337, Aug. 6, 1964, as amended by Amdt. 171–7, 35 FR 12711, Aug. 11, 1970]

§ 171.5 Minimum requirements for approval.

(a) The following are the minimum requirements that must be met before the FAA will approve an IFR procedure for a non-Federal VOR:

(1) The facility's performance, as determined by air and ground inspection, must meet the requirements of § 171.7.

(2) The installation of the equipment must meet the requirements of § 171.9.

(3) The owner must agree to operate and maintain the facility in accordance with § 171.11.

(4) The owner must agree to furnish periodic reports, as set forth in § 171.13, and must agree to allow the FAA to inspect the facility and its operation whenever necessary.

(5) The owner must assure the FAA that he will not withdraw the facility from service without the permission of the FAA.

(6) The owner must bear all costs of meeting the requirements of this section and of any flight or ground inspections made before the facility is commissioned, except that the Federal Aviation Administration may bear certain of these costs subject to budgetary limitations and policy established by the Administrator.

(b) If the applicant for approval meets the requirements of paragraph (a) of this section, the FAA commissions the facility as a prerequisite to its approval for use in an IFR procedure. The approval is withdrawn at any time the facility does not continue to meet those requirements.

[Doc. No. 5034, 29 FR 11337, Aug. 6, 1964, as amended by Amdt. 171–6, 35 FR 10288, June 24, 1970]

§ 171.7 Performance requirements.

(a) The VOR must perform in accordance with the "International Standards and Recommended Practices, Aeronautical Telecommunications," Part I, paragraph 3.3 (Annex 10 to the Convention on International Civil Aviation), except that part of paragraph 3.3.2.1 specifying a radio frequency tolerance of 0.005 percent, and that part of paragraph 3.3.7 requiring removal of only the bearing information. In place thereof, the frequency tolerance of the radio frequency carrier must not exceed plus or minus 0.002 percent, and all radiation must be removed during the specified deviations from established conditions and during periods of monitor failure.

(b) Ground inspection consists of an examination of the design features of the equipment to determine that there will not be conditions that will allow unsafe operations because of component failure or deterioration.

(c) The monitor is checked periodically, during the in-service test evaluation period, for calibration and stability. The tests are made with a standard "Reference and variable phase signal generator" and associated test equipment, including an oscilloscope and portable field detector. In general, the ground check is conducted in accordance with section 8.4 of FAA Handbook AF P 6790.9 "Maintenance Instruction for VHF Omnidirectional", adapted for the facility concerned.

(d) Flight tests to determine the facility's adequacy for operational requirements and compliance with applicable "Standards and Recommended Practices" are conducted in accordance with the "U.S. Standard Flight Inspection Manual", particularly section 201.

(e) After January 1, 1975, the owner of the VOR shall modify the facility to perform in accordance with paragraph 3.3.5.7 of Annex 10 to the Convention on International Civil Aviation within 180 days after receipt of notice from the Administrator that 50 kHz channel spacing is to be implemented in the area and that a requirement exists for suppression of 9960 Hz subcarrier harmonics.

[Doc. No. 5034, 29 FR 11337, Aug. 6, 1964, as amended by Amdt. 171-7, 35 FR 12711, Aug. 11, 1970; Amdt. 171-9, 38 FR 28557, Oct. 15, 1973]

§ 171.9 Installation requirements.

(a) The facility must be installed according to accepted good engineering practices, applicable electric and safety codes, and the installation must meet at least the Federal Communications Commission's licensing requirements.

(b) The facility must have a reliable source of suitable primary power, either from a power distribution system or locally generated, with a supplemental standby system, if needed.

(c) Dual transmitting equipment with automatic changeover is preferred and may be required to support certain IFR procedures.

(d) There must be a means for determining, from the ground, the performance of the equipment, including the antenna, initially and periodically.

(e) A facility intended for use as an instrument approach aid for an airport must have or be supplemented by (de-

pending on circumstances) the following ground-air or landline communications services:

(1) At facilities outside of and not immediately adjacent to controlled airspace, there must be ground-air communications from the airport served by the facility. Separate communications channels are acceptable.

(2) At facilities within or immediately adjacent to controlled airspace, there must be the ground-air communications required by paragraph (e)(1) of this section and reliable communications (at least a landline telephone) from the airport to the nearest FAA air traffic control or communication facility.

Paragraphs (e) (1) and (2) of this section are not mandatory at airports where an adjacent FAA facility can communicate with aircraft on the ground at the airport and during the entire proposed instrument approach procedure. In addition, at low traffic density airports within or immediately adjacent to controlled airspace and where extensive delays are not a factor, the requirements of paragraphs (e) (1) and (2) of this section may be reduced to reliable communications (at least a landline telephone) from the airport to the nearest FAA air traffic control or communication facility, if an adjacent FAA facility can communicate with aircraft during the proposed instrument approach procedure, at least down to the minimum en route altitude for the controlled airspace area.

[Doc. No. 5034, 29 FR 11337, Aug. 6, 1964, as amended by Amdt. 171-7, 35 FR 12711, Aug. 11, 1970; Amdt. 171-16, 56 FR 65664, Dec. 17, 1991]

§ 171.11 Maintenance and operations requirements.

(a) The owner of the facility must establish an adequate maintenance system and provide qualified maintenance personnel to maintain the facility at the level attained at the time it was commissioned. Each person who maintains a facility must meet at least the Federal Communications Commission's licensing requirements and show that he has the special knowledge and skills

§ 171.11

14 CFR Ch. I (1-1-24 Edition)

needed to maintain the facility including proficiency in maintenance procedures and the use of specialized test equipment.

(b) The owner must prepare, and obtain FAA approval of, an operations and maintenance manual that sets forth mandatory procedures for operations, preventive maintenance, and emergency maintenance, including instructions on each of the following:

- (1) Physical security of the facility.
- (2) Maintenance and operations by authorized persons only.
- (3) FCC licensing requirements for operating and maintenance personnel.
- (4) Posting of licenses and signs.
- (5) Relations between the facility and FAA air traffic control facilities, with a description of the boundaries of controlled airspace over or near the facility, instructions for relaying air traffic control instructions and information (if applicable), and instructions for the operation of an air traffic advisory service if the VOR is located outside of controlled airspace.
- (6) Notice to the Administrator of any suspension of service.
- (7) Detailed and specific maintenance procedures and servicing guides stating the frequency of servicing.
- (8) Air-ground communications, if provided, expressly written or incorporating appropriate sections of FAA manuals by reference.
- (9) Keeping of station logs and other technical reports, and the submission of reports required by § 171.13.
- (10) Monitoring of the facility.
- (11) Inspections by United States personnel.
- (12) Names, addresses, and telephone numbers of persons to be notified in an emergency.
- (13) Shutdowns for routine maintenance and issue of "Notices to Airmen" for routine or emergency shutdowns (private use facilities may omit the "Notices to Airmen").
- (14) An explanation of the kinds of activity (such as construction or grading) in the vicinity of the facility that may require shutdown or recertification of the facility by FAA flight check.
- (15) Procedures for conducting a ground check of course accuracy.
- (16) Commissioning of the facility.

(17) An acceptable procedure for amending or revising the manual.

(18) The following information concerning the facility:

- (i) Location by latitude and longitude to the nearest second, and its position with respect to airport layouts.
- (ii) The type, make, and model of the basic radio equipment that will provide the service.
- (iii) The station power emission and frequency.
- (iv) The hours of operation.
- (v) Station identification call letters and method of station identification, whether by Morse code or recorded voice announcement, and the time spacing of the identification.
- (vi) A description of the critical parts that may not be changed, adjusted, or repaired without an FAA flight check to confirm published operations.
- (c) The owner shall make a ground check of course accuracy each month in accordance with procedures approved by the FAA at the time of commissioning, and shall report the results of the checks as provided in § 171.13.
- (d) If the owner desires to modify the facility, he must submit the proposal to the FAA and may not allow any modifications to be made without specific approval.
- (e) The owner's maintenance personnel must participate in initial inspections made by the FAA. In the case of subsequent inspections, the owner or his representative shall participate.
- (f) Whenever it is required by the FAA, the owner shall incorporate improvements in VOR maintenance brought about by progress in the state of the art. In addition, he shall provide a stock of spare parts, including vacuum tubes, of such a quantity to make possible the prompt replacement of components that fail or deteriorate in service.
- (g) The owner shall provide all approved test instruments needed for maintenance of the facility.
- (h) The owner shall close the facility upon receiving two successive pilot reports of its malfunctioning.

[Doc. No. 5034, 29 FR 11337, Aug. 6, 1964, as amended by Amdt. 171-2, 31 FR 5408, Apr. 6, 1966]

§ 171.13 Reports.

The owner of each facility to which this subpart applies shall make the following reports on forms furnished by the FAA, at the times indicated, to the FAA Regional office for the area in which the facility is located:

(a) *Record of meter readings and adjustments (Form FAA-198)*. To be filled out by the owner with the equipment adjustments and meter readings as of the time of commissioning, with one copy to be kept in the permanent records of the facility and two copies to the appropriate Regional office of the FAA. The owner shall revise the form after any major repair, modernization, or returning, to reflect an accurate record of facility operation and adjustment.

(b) *Facility maintenance log (FAA Form 6003-1)*. This form is a permanent record of all equipment malfunctioning met in maintaining the facility, including information on the kind of work and adjustments made, equipment failures, causes (if determined), and corrective action taken. The owner shall keep the original of each report at the facility and send a copy to the appropriate Regional office of the FAA at the end of the month in which it is prepared.

(c) *Radio equipment operation record (Form FAA-418)*. To contain a complete record of meter readings, recorded on each scheduled visit to the facility. The owner shall keep the original of each month's record at the facility and send a copy of it to the appropriate Regional office of the FAA.

(d) [Reserved]

(e) *VOR ground check error data (Forms FAA-2396 and 2397)*. To contain results of the monthly course accuracy ground check in accordance with FAA Handbook AF P 6790.9 "Maintenance Instructions for VHF Omnidirectional". The owner shall keep the originals in the facility and send a copy of each form to the appropriate Regional office of the FAA on a monthly basis.

(49 U.S.C. 1348)

[Doc. No. 5034, 29 FR 11337, Aug. 6, 1964, as amended by Amdt. 171-5, 34 FR 15245, Sept. 30, 1969; Amdt. 171-10, 40 FR 36110, Aug. 19, 1975]

Subpart B—Nondirectional Radio Beacon Facilities**§ 171.21 Scope.**

(a) This subpart sets forth minimum requirements for the approval and operation of non-Federal, nondirectional radio beacon facilities that are to be involved in the approval of instrument flight rules and air traffic control procedures related to those facilities.

(b) A nondirectional radio beacon ("H" facilities domestically—NDB facilities internationally) radiates a continuous carrier of approximately equal intensity at all azimuths. The carrier is modulated at 1020 cycles per second for station identification purposes.

[Doc. No. 5034, 29 FR 11337, Aug. 6, 1964, as amended by Amdt. 171-2, 31 FR 5408, Apr. 6, 1966; Amdt. 171-7, 35 FR 12711, Aug. 11, 1970]

§ 171.23 Requests for IFR procedure.

(a) Each person who requests an IFR procedure based on a nondirectional radio beacon facility that he owns must submit the following information with that request:

(1) A description of the facility and evidence that the equipment meets the performance requirements of §171.27 and is installed in accordance with §171.29.

(2) A proposed procedure for operating the facility.

(3) A proposed maintenance arrangement and a maintenance manual that meets the requirements of §171.31.

(4) A statement of intention to meet the requirements of this subpart.

(5) A showing that the facility has an acceptable level of operational reliability and an acceptable standard of performance. Previous equivalent operational experience with a facility with identical design and operational characteristics will be considered in showing compliance with this subparagraph.

(b) After the FAA inspects and evaluates the facility, it advises the owner of the results and of any required changes in the facility or the maintenance manual or maintenance organization. The owner must then correct the deficiencies, if any, and operate the

§ 171.25

facility for an in-service evaluation by the FAA.

[Doc. No. 5034, 29 FR 11337, Aug. 6, 1964, as amended by Amdt. 171-7, 35 FR 12711, Aug. 11, 1970]

§ 171.25 Minimum requirements for approval.

(a) The following are the minimum requirements that must be met before the FAA will approve an IFR procedure for a non-Federal, nondirectional radio beacon facility under this subpart:

(1) The facility's performances, as determined by air and ground inspection, must meet the requirements of § 171.27.

(2) The installation of the equipment must meet the requirements of § 171.29.

(3) The owner must agree to operate and maintain the facility in accordance with § 171.31.

(4) The owner must agree to furnish periodic reports, as set forth in § 171.33, and agree to allow the FAA to inspect the facility and its operation whenever necessary.

(5) The owner must assure the FAA that he will not withdraw the facility from service without the permission of the FAA.

(6) The owner must bear all costs of meeting the requirements of this section and of any flight or ground inspections made before the facility is commissioned, except that the Federal Aviation Administration may bear certain of these costs subject to budgetary limitations and policy established by the Administrator.

(b) If the applicant for approval meets the requirements of paragraph (a) of this section, the FAA commissions the facility as a prerequisite to its approval for use in an IFR procedure. The approval is withdrawn at any time the facility does not continue to meet those requirements. In addition, the facility may be de-commissioned whenever the frequency channel is needed for higher priority common system service.

[Doc. No. 5034, 29 FR 11337, Aug. 6, 1964, as amended by Amdt. 171-6, 35 FR 10288, June 24, 1970]

§ 171.27 Performance requirements.

(a) The facility must meet the performance requirements set forth in the "International Standards and Rec-

14 CFR Ch. I (1-1-24 Edition)

ommended Practices, Aeronautical Telecommunications, Part I, paragraph 3.4" (Annex 10 to the Convention on International Civil Aviation), except that identification by on-off keying of a second carrier frequency, separated from the main carrier by 1020 Hz plus or minus 50 Hz, is also acceptable.

(b) The facility must perform in accordance with recognized and accepted good electronic engineering practices for the desired service.

(c) Ground inspection consists of an examination of the design features of the equipment to determine (based on recognized and accepted good engineering practices) that there will not be conditions that will allow unsafe operations because of component failure or deterioration.

(d) Flight tests to determine the facility's adequacy for operational requirements and compliance with applicable "Standards and Recommended Practices" are conducted in accordance with the "U.S. Standard Flight Inspection Manual", particularly section 207. The original test is made by the FAA and later tests shall be made under arrangements, satisfactory to the FAA, that are made by the owner.

[Doc. No. 5034, 29 FR 11337, Aug. 6, 1964, as amended by Amdt. 171-7, 35 FR 12711, Aug. 11, 1970]

§ 171.29 Installation requirements.

(a) The facility must be installed according to accepted good engineering practices, applicable electric and safety codes, and FCC licensing requirements.

(b) The facility must have a reliable source of suitable primary power.

(c) Dual transmitting equipment may be required to support some IFR procedures.

(d) A facility intended for use as an instrument approach aid for an airport must have or be supplemented by (depending on the circumstances) the following ground-air or landline communications services:

(1) At facilities outside of and not immediately adjacent to controlled airspace, there must be ground-air communications from the airport served by the facility. Voice on the aid controlled from the airport is acceptable.

(2) At facilities within or immediately adjacent to controlled airspace, there must be the ground-air communications required by paragraph (d)(1) of this section and reliable communications (at least a landline telephone) from the airport to the nearest FAA air traffic control or communication facility.

Paragraphs (d) (1) and (2) of this section are not mandatory at airports where an adjacent FAA facility can communicate with aircraft on the ground at the airport and during the entire proposed instrument approach procedure. In addition, at low traffic density airports within or immediately adjacent to controlled airspace, and where extensive delays are not a factor, the requirements of paragraphs (d) (1) and (2) of this section may be reduced to reliable communications (at least a landline telephone) from the airport to the nearest FAA air traffic control or communications facility, if an adjacent FAA facility can communicate with aircraft during the proposed instrument approach procedure, at least down to the minimum en route altitude for the controlled airspace area.

[Doc. No. 5034, 29 FR 11337, Aug. 6, 1964, as amended by Amdt. 171-16, 56 FR 65664, Dec. 17, 1991]

§ 171.31 Maintenance and operations requirements.

(a) The owner of the facility must establish an adequate maintenance system and provide qualified maintenance personnel to maintain the facility at the level attained at the time it was commissioned. Each person who maintains a facility must meet at least the Federal Communications Commission's licensing requirements and show that he has the special knowledge and skills needed to maintain the facility including proficiency in maintenance procedures and the use of specialized test equipment.

(b) The owner must prepare, and obtain approval of, an operations and maintenance manual that sets forth mandatory procedures for operations, preventive maintenance, and emergency maintenance, including instructions on each of the following:

(1) Physical security of the facility.

(2) Maintenance and operations by authorized persons only.

(3) FCC licensing requirements for operating and maintenance personnel.

(4) Posting of licenses and signs.

(5) Relations between the facility and FAA air traffic control facilities, with a description of the boundaries of controlled airspace over or near the facility, instructions for relaying air traffic control instructions and information (if applicable), and instructions for the operation of an air traffic advisory service if the facility is located outside of controlled airspace.

(6) Notice to the Administrator of any suspension of service.

(7) Detailed arrangements for maintenance flight inspection and servicing stating the frequency of servicing.

(8) Air-ground communications, if provided, expressly written or incorporating appropriate sections of FAA manuals by reference.

(9) Keeping of station logs and other technical reports, and the submission of reports required by § 171.33.

(10) Monitoring of the facility, at least once each half hour, to assure continuous operation.

(11) Inspections by United States personnel.

(12) Names, addresses, and telephone numbers of persons to be notified in an emergency.

(13) Shutdowns for routine maintenance and issue of "Notices to Airmen" for routine or emergency shutdowns (private use facilities may omit the "Notices to Airmen").

(14) Commissioning of the facility.

(15) An acceptable procedure for amending or revising the manual.

(16) The following information concerning the facility:

(i) Location by latitude and longitude to the nearest second, and its position with respect to airport layouts.

(ii) The type, make, and model of the basic radio equipment that will provide the service.

(iii) The station power emission and frequency.

(iv) The hours of operation.

(v) Station identification call letters and method of station identification, whether by Morse code or recorded

§ 171.33

voice announcement, and the time spacing of the identification.

(c) If the owner desires to modify the facility, he must submit the proposal to the FAA and meet applicable requirements of the FCC.

(d) The owner's maintenance personnel must participate in initial inspections made by the FAA. In the case of subsequent inspections, the owner or his representative shall participate.

(e) The owner shall provide a stock of spare parts, including vacuum tubes, of such a quantity to make possible the prompt replacement of components that fail or deteriorate in service.

(f) The owner shall close the facility upon receiving two successive pilot reports of its malfunctioning.

[Doc. No. 5034, 29 FR 11337, Aug. 6, 1964, as amended by Amdt. 171-2, 31 FR 5408, Apr. 6, 1966]

§ 171.33 Reports.

The owner of each facility to which this subpart applies shall make the following reports, at the times indicated, to the FAA Regional office for the area in which the facility is located:

(a) *Record of meter readings and adjustments (Form FAA-198)*. To be filled out by the owner or his maintenance representative with the equipment adjustments and meter readings as of the time of commissioning, with one copy to be kept in the permanent records of the facility and two copies to the appropriate Regional Office of the FAA. The owner shall revise the form after any major repair, modernization, or returning, to reflect an accurate record of facility operation and adjustment.

(b) *Facility maintenance log (FAA Form 6030-1)*. This form is a permanent record of all equipment malfunctioning met in maintaining the facility, including information on the kind of work and adjustments made, equipment failures, causes (if determined), and corrective action taken. The owner shall keep the original of each report at the facility and send a copy to the appropriate Regional Office of the FAA at the end of the month in which it is prepared.

(c) *Radio equipment operation record (Form FAA-418)*. To contain a complete record of meter readings, recorded on each scheduled visit to the facility.

14 CFR Ch. I (1-1-24 Edition)

The owner shall keep the original of each month's record at the facility and send a copy of it to the appropriate Regional Office of the FAA.

[Doc. No. 5034, 29 FR 11337, Aug. 6, 1964, as amended by Amdt. 171-10, 40 FR 36110, Aug. 19, 1975]

Subpart C—Instrument Landing System (ILS) Facilities

§ 171.41 Scope.

This subpart sets forth minimum requirements for the approval and operation of non-Federal Instrument Landing System (ILS) Facilities that are to be involved in the approval of instrument flight rules and air traffic control procedures related to those facilities.

[Doc. No. 5034, 29 FR 11337, Aug. 6, 1964, as amended by Amdt. 171-2, 31 FR 5408, Apr. 6, 1966; Amdt. 171-7, 35 FR 12711, Aug. 11, 1970]

§ 171.43 Requests for IFR procedure.

(a) Each person who requests an IFR procedure based on an ILS facility that he owns must submit the following information with that request:

(1) A description of the facility and evidence that the equipment meets the performance requirements of §171.47 and is installed in accordance with §171.49.

(2) A proposed procedure for operating the facility.

(3) A proposed maintenance organization and a maintenance manual that meets the requirements of §171.51.

(4) A statement of intent to meet the requirements of this subpart.

(5) A showing that the facility has an acceptable level of operational reliability and an acceptable standard of performance. Previous equivalent operational experience with a facility with identical design and operational characteristics will be considered in showing compliance with this subparagraph.

(b) After the FAA inspects and evaluates the facility, it advises the owner of the results and of any required changes in the facility or the maintenance manual or maintenance organization. The owner must then correct the deficiencies, if any, and operate the

Federal Aviation Administration, DOT

§ 171.47

facility for an in-service evaluation by the FAA.

[Doc. No. 5034, 29 FR 11337, Aug. 6, 1964, as amended by Amdt. 171-7, 35 FR 12711, Aug. 11, 1970]

§ 171.45 Minimum requirements for approval.

(a) The following are the minimum requirements that must be met before the FAA will approve an IFR procedure for a non-Federal Instrument Landing System:

(1) The facility's performance, as determined by air and ground inspection, must meet the requirements of § 171.47.

(2) The installation of the equipment must meet the requirements of § 171.49.

(3) The owner must agree to operate and maintain the facility in accordance with § 171.51.

(4) The owner must agree to furnish periodic reports, as set forth in § 171.53 and agree to allow the FAA to inspect the facility and its operation whenever necessary.

(5) The owner must assure the FAA that he will not withdraw the facility from service without the permission of the FAA.

(6) The owner must bear all costs of meeting the requirements of this section and of any flight or ground inspections made before the facility is commissioned, except that the Federal Aviation Administration may bear certain of these costs subject to budgetary limitations and policy established by the Administrator.

(b) If the applicant for approval meets the requirements of paragraph (a) of this section, the FAA commissions the facility as a prerequisite to its approval for use in an IFR procedure. The approval is withdrawn at any time the facility does not continue to meet those requirements. In addition, the facility may be de-commissioned whenever the frequency channel is needed for higher priority common system service.

[Doc. No. 5034, 29 FR 11337, Aug. 6, 1964, as amended by Amdt. 171-6, 35 FR 10288, June 24, 1970]

§ 171.47 Performance requirements.

(a) The Instrument Landing System must perform in accordance with the "International Standards and Rec-

ommended Practices, Aeronautical Telecommunications, Part I, Paragraph 3.1" (Annex 10 to the Convention on International Civil Aviation) except as follows:

(1) The first part of paragraph 3.1.3, relating to suppression of radiation wholly or in part in any or all directions outside the 20-degree sector centered on the course line to reduce localizer does not apply.

(2) Radiation patterns must conform to limits specified in 3.1.3.3 and 3.1.3.4, but this does not mean that suppression of radiation to the rear of the antenna array to satisfy difficult siting positions (as per 3.1.3.1.4) is not allowed. For example, if a reflector screen for the antenna array is required to overcome a siting problem, the area to the rear of the localizer may be made unusable and should be so advertised.

(3) A third marker beacon (inner marker) is not required.

(4) The frequency tolerance of the radio frequency carrier must not exceed plus or minus 0.002 percent.

(b) Ground inspection consists of an examination of the design features of the equipment to determine that there will not be conditions that will allow unsafe operations because of component failure or deterioration.

(c) The monitor is checked periodically, during the in-service test evaluation period, for calibration and stability. These tests, and ground checks of glide slope and localizer radiation characteristics, are conducted in accordance with FAA Handbooks AF P 6750.1 and AF P 6750.2 "Maintenance Instructions for ILS Localizer Equipment" and "Maintenance Instructions for ILS Glide Slope Equipment".

(d) Flight tests to determine the facility's adequacy for operational requirements and compliance with applicable "Standards and Recommended Practices" are conducted in accordance with the "U.S. Standard Flight Inspection Manual", particularly section 217.

[Doc. No. 5034, 29 FR 11337, Aug. 6, 1974, as amended by Amdt. 171-9, 38 FR 28557, Oct. 15, 1973]

§ 171.49 Installation requirements.

(a) The facility must be of a permanent nature, located, constructed, and installed according to ICAO Standards (Annex 10), accepted good engineering practices, applicable electric and safety codes, and FCC licensing requirements.

(b) The facility must have a reliable source of suitable primary power, either from a power distribution system or locally generated. A determination by the Administrator as to whether a facility will be required to have standby power for the localizer, glide slope and monitor accessories to supplement the primary power, will be made for each airport based upon operational minimums and density of air traffic.

(c) A determination by the Administrator as to whether a facility will be required to have dual transmitting equipment with automatic changeover for localizer and glide slope components, will be made for each airport based upon operational minimums and density of air traffic.

(d) There must be a means for determining, from the ground, the performance of the equipment (including antennae), initially and periodically.

(e) The facility must have, or be supplemented by (depending on the circumstances) the following ground-air or landline communications services:

(1) At facilities outside of and not immediately adjacent to controlled airspace, there must be ground-air communications from the airport served by the facility. The utilization of voice on the ILS frequency should be determined by the facility operator on an individual basis.

(2) At facilities within or immediately adjacent to controlled airspace, there must be the ground-air communications required by paragraph (e)(1) of this section and reliable communications (at least a landline telephone) from the airport to the nearest FAA air traffic control or communications facility.

Paragraphs (e)(1) and (e)(2) of this section are not mandatory at airports where an adjacent FAA facility can communicate with aircraft on the ground at the airport and during the entire proposed instrument approach

procedure. In addition, at low traffic density airports within or immediately adjacent to controlled airspace, and where extensive delays are not a factor, the requirements of paragraphs (e)(1) and (e)(2) of this section may be reduced to reliable communications (at least a landline telephone) from the airport to the nearest FAA air traffic control or communications facility, if an adjacent FAA facility can communicate with aircraft during the proposed instrument approach procedure down to the airport surface or at least to the minimum approach altitude.

[Doc. No. 5034, 29 FR 11337, Aug. 6, 1964, as amended by Amdt. 171-6, 35 FR 10288, June 24, 1970; Amdt. 171-16, 56 FR 65664, Dec. 17, 1991]

§ 171.51 Maintenance and operations requirements.

(a) The owner of the facility must establish an adequate maintenance system and provide qualified maintenance personnel to maintain the facility at the level attained at the time it was commissioned. Each person who maintains a facility must meet at least the Federal Communications Commission's licensing requirements and show that he has the special knowledge and skills needed to maintain the facility including proficiency in maintenance procedures and the use of specialized test equipment.

(b) The owner must prepare, and obtain approval of, an operations and maintenance manual that sets forth mandatory procedures for operations, preventive maintenance, and emergency maintenance, including instructions on each of the following:

- (1) Physical security of the facility.
- (2) Maintenance and operations by authorized persons only.
- (3) FCC licensing requirements for operating and maintenance personnel.
- (4) Posting of licenses and signs.
- (5) Relation between the facility and FAA air traffic control facilities, with a description of the boundaries of controlled airspace over or near the facility, instructions for relaying air traffic control instructions and information (if applicable), and instructions for the operations of an air traffic advisory service if the facility is located outside of controlled airspace.

(6) Notice to the Administrator of any suspension of service.

(7) Detailed and specific maintenance procedures and servicing guides stating the frequency of servicing.

(8) Air-ground communications, if provided, expressly written or incorporating appropriate sections of FAA manuals by reference.

(9) Keeping of station logs and other technical reports, and the submission of reports required by § 171.53.

(10) Monitoring of the facility.

(11) Inspections by United States personnel.

(12) Names, addresses, and telephone numbers of persons to be notified in an emergency.

(13) Shutdowns for routine maintenance and issue of "Notices to Airmen" for routine or emergency shutdowns (private use facilities may omit the "Notices to Airmen").

(14) Commissioning of the facility.

(15) An acceptable procedure for amending or revising the manual.

(16) An explanation of the kinds of activities (such as construction or grading) in the vicinity of the facility that may require shutdown or recertification of the facility by FAA flight check.

(17) Procedures for conducting a ground check or localizer course alignment width, and clearance, and glide slope elevation angle and width.

(18) The following information concerning the facility:

(i) Facility component locations with respect to airport layout, instrument runway, and similar areas.

(ii) The type, make, and model of the basic radio equipment that will provide the service.

(iii) The station power emission and frequencies of the localizer, glide slope, markers, and associated compass locators, if any.

(iv) The hours of operation.

(v) Station identification call letters and method of station identification and the time spacing of the identification.

(vi) A description of the critical parts that may not be changed, adjusted, or repaired without an FAA flight check to confirm published operations.

(c) The owner shall make a ground check of the facility each month in ac-

cordance with procedures approved by the FAA at the time of commissioning, and shall report the results of the checks as provided in § 171.53.

(d) If the owner desires to modify the facility, he must submit the proposal to the FAA and may not allow any modifications to be made without specific approval.

(e) "The owner's maintenance personnel must participate in initial inspections made by the FAA. In the case of subsequent inspections, the owner or his representative shall participate."

(f) Whenever it is required by the FAA, the owner shall incorporate improvements in ILS maintenance brought about by progress in the state of the art. In addition, he shall provide a stock of spare parts, including vacuum tubes, of such a quantity to make possible the prompt replacement of components that fail or deteriorate in service.

(g) The owner shall provide FAA approved test instruments needed for maintenance of the facility.

(h) The owner shall close the facility upon receiving two successive pilot reports of its malfunctioning.

[Doc. No. 5034, 29 FR 11337, Aug. 6, 1964, as amended by Amdt. 171-2, 31 FR 5408, Apr. 6, 1966]

§ 171.53 Reports.

The owner of each facility to which this subpart applies shall make the following reports, at the times indicated, to the FAA Regional Office for the area in which the facility is located:

(a) *Record of meter readings and adjustments (Form FAA-198)*. To be filled out by the owner or his maintenance representative with the equipment adjustments and meter readings as of the time of commissioning, with one copy to be kept in the permanent records of the facility and two copies to the appropriate Regional Office of the FAA. The owner shall revise the form after any major repair, modernization, or retuning, to reflect an accurate record of facility operation and adjustment.

(b) *Facility maintenance log (Form FAA 6030-1)*. This form is a permanent record of all equipment malfunctioning met in maintaining the facility, including information on the kind of

§ 171.61

work and adjustments made, equipment failures, causes (if determined), and corrective action taken. The owner shall keep the original of each report at the facility and send a copy to the appropriate Regional Office of the FAA at the end of each month in which it is prepared.

(c) *Radio equipment operation record (Form FAA-418)*. To contain a complete record of meter readings, recorded on each scheduled visit to the facility. The owner shall keep the original of each month's record at the facility and send a copy of it to the appropriate Regional Office of the FAA.

[Doc. No. 5034, 29 FR 11337, Aug. 6, 1964, as amended by Amdt. 171-5, 34 FR 15245, Sept. 30, 1969; Amdt. 171-10, 40 FR 36110, Aug. 19, 1975]

Subpart D—True Lights

§ 171.61 Air navigation certificate: Revocation and termination.

(a) Except as provided in paragraph (b) of this section, each air navigation certificate of "Lawful Authority to Operate a True Light" is hereby revoked, and each application therefor is hereby terminated.

(b) Paragraph (a) of this section does not apply to—

(1) A certificate issued to a Federal-Aid Airport Program sponsor who was required to apply for that certificate under regulations then in effect, and who has not surrendered that certificate under § 151.86(e) of this chapter; or

(2) An application made by a Federal-Aid Airport Program sponsor who was required to make that application under regulations then in effect, and who has not terminated that application under § 151.86(e) of this chapter.

(49 U.S.C. 1101-1120; sec. 307, 72 Stat. 749, 49 U.S.C. 1348)

[Amdt. 171-4, 33 FR 12545, Sept. 5, 1968]

Subpart E—General

§ 171.71 Materials incorporated by reference.

Copies of standards, recommended practices and documents incorporated by reference in this part are available for the use of interested persons at any FAA Regional Office and FAA Head-

14 CFR Ch. I (1-1-24 Edition)

quarters. An historical file of these materials is maintained at Headquarters, Federal Aviation Administration, 800 Independence Avenue SW., Washington, DC 20590.

[Amdt. 171-8, 36 FR 5584, Mar. 25, 1971]

§ 171.73 Alternative forms of reports.

On a case-by-case basis, a Regional Administrator may accept any report in a format other than the FAA form required by this part if he is satisfied that the report contains all the information required on the FAA form and can be processed by FAA as conveniently as the FAA form.

(49 U.S.C. 1348)

[Amdt. 171-5, 34 FR 15245, Sept. 30, 1969, as amended by Amdt. 171-15, 54 FR 39296, Sept. 25, 1989]

§ 171.75 Submission of requests.

(a) Requests for approval of facilities not having design and operational characteristics identical to those of facilities currently approved under this part, including requests for deviations from this part for such facilities, must be submitted to the Director, Advanced Systems Design Service.

(b) The following requests must be submitted to the Regional Administrator of the region in which the facility is located:

(1) Requests for approval of facilities that have design and operational characteristics identical to those of facilities currently approved under this part, including requests for deviations from this part for such facilities.

(2) Requests for deviations from this part for facilities currently approved under this part.

(3) Requests for modification of facilities currently approved under this part.

[Amdt. 171-7, 35 FR 12711, Aug. 11, 1970, as amended by Amdt. 171-15, 54 FR 39296, Sept. 25, 1989]

Subpart F—Simplified Directional Facility (SDF)

SOURCE: Docket No. 10116, 35 FR 12711, Aug. 11, 1970, unless otherwise noted.

§ 171.101 Scope.

This subpart sets forth minimum requirements for the approval and operation of non-Federal Simplified Directional Facilities (SDF) that are to be involved in the approval of instrument flight rules and air traffic control procedures related to those facilities.

§ 171.103 Requests for IFR procedure.

(a) Each person who requests an IFR procedure based on an SDF that he owns must submit the following information with that request:

(1) A description of the facility and evidence that the equipment meets the performance requirements of §171.109 and the standards and tolerances of §171.111, and is installed in accordance with §171.113.

(2) A proposed procedure for operating the facility.

(3) A proposed maintenance organization and a maintenance manual that meets the requirements of §171.115.

(4) A statement of intent to meet the requirements of this subpart.

(5) A showing that the facility has an acceptable level of operational reliability as prescribed in §171.111(k), and an acceptable standard of performance. Previous equivalent operational experience with a facility with identical design and operational characteristics will be considered in showing compliance with this paragraph.

(b) After the Federal Aviation Administration inspects and evaluates the facility, it advises the owner of the results and of any required changes in the facility or the maintenance manual or maintenance organization. The owner must then correct the deficiencies, if any, and operate the facility for an in-service evaluation by the Federal Aviation Administration.

§ 171.105 Minimum requirements for approval.

(a) The following are the minimum requirements that must be met before the Federal Aviation Administration will approve an IFR procedure for a non-Federal Simplified Directional Facility:

(1) A suitable frequency channel must be available.

(2) The facility's performance, as determined by air and ground inspection,

must meet the requirements of §§171.109 and 171.111.

(3) The installation of the equipment must meet the requirements of §171.113.

(4) The owner must agree to operate and maintain the facility in accordance with §171.115.

(5) The owner must agree to furnish periodic reports as set forth in §171.117, and agree to allow the FAA to inspect the facility and its operation whenever necessary.

(6) The owner must assure the FAA that he will not withdraw the facility from service without the permission of the FAA.

(7) The owner must bear all costs of meeting the requirements of this section and of any flight or ground inspections made before the facility is commissioned, except that the FAA may bear certain of these costs subject to budgetary limitations and policy established by the Administrator.

(b) If the applicant for approval meets the requirements of paragraph (a) of this section, the FAA commissions the facility as a prerequisite to its approval for use in an IFR procedure. The approval is withdrawn at any time the facility does not continue to meet those requirements. In addition, the facility is licensed by the Federal Communications Commission. The Federal Aviation Administration recommends cancellation or nonrenewal of the Federal Communications Commission license whenever the frequency channel is needed for higher priority common system service.

§ 171.107 Definition.

As used in this subpart:

SDF (simplified directional facility) means a directional aid facility providing only lateral guidance (front or back course) for approach from a final approach fix.

DDM (difference in depth of modulation) means the percentage modulation depth of the larger signal minus the percentage modulation depth of the smaller signal, divided by 100.

Angular displacement sensitivity means the ratio of measured DDM to the corresponding angular displacement from the appropriate reference line.

Back course sector means the course sector on the opposite end of the runway from the front course sector.

Course line means the locus of points along the final approach course at which the DDM is zero.

Course sector means a sector in a horizontal plane containing the course line and limited by the loci of points nearest to the course line at which the DDM is 0.155.

Displacement sensitivity means the ratio of measured DDM to the corresponding lateral displacement from the appropriate reference line.

Front course sector means the course sector centered on the course line in the direction from the runway in which a normal final approach is made.

Half course sector means the sector in a horizontal plane containing the course line and limited by the loci of points nearest to the course line, at which the DDM is 0.0775.

Point A means a point on the front course in the approach direction a distance of 4 nautical miles from the threshold.

Point A1 means a point on the front course in the approach direction a distance of 1 statute mile from the threshold.

Point A2 means a point on the front course at the threshold.

Reference datum means a point at a specified height located vertically above the intersection of the course and the threshold.

Missed approach point means the point on the final approach course, not farther from the final approach fix than Point "A2", at which the approach must be abandoned, if the approach and subsequent landing cannot be safely completed by visual reference, whether or not the aircraft has descended to the minimum descent altitude.

§ 171.109 Performance requirements.

(a) The Simplified Directional Facility must perform in accordance with the following standards and practices:

(1) The radiation from the SDF antenna system must produce a composite field pattern which is amplitude modulated by a 90 Hz and a 150 Hz tone. The radiation field pattern must produce a course sector with the 90 Hz

tone predominating on one side of the course and with the 150 Hz tone predominating on the opposite side.

(2) When an observer faces the SDF from the approach end of runway, the depth of modulation of the radio frequency carrier due to the 150 Hz tone must predominate on his right hand and that due to the 90 Hz tone must predominate on his left hand.

(3) All horizontal angles employed in specifying the SDF field patterns must originate from the center of the antenna system which provides the signals used in the front course sector.

(4) The SDF must operate on odd tenths or odd tenths plus a twentieth MHz within the frequency band 108.1 MHz to 111.95 MHz. The frequency tolerance of the radio frequency carrier must not exceed plus or minus 0.002 percent.

(5) The radiated emission from the SDF must be horizontally polarized. The vertically polarized component of the radiation on the course line must not exceed that which corresponds to an error one-twentieth of the course sector width when an aircraft is positioned on the course line and is in a roll attitude of 20° from the horizontal.

(6) The SDF must provide signals sufficient to allow satisfactory operation of a typical aircraft installation within the sector which extends from the center of the SDF antenna system to distances of 18 nautical miles within a plus or minus 10° sector and 10 nautical miles within the remainder of the coverage when alternative navigational facilities provide satisfactory coverage within the intermediate approach area. SDF signals must be receivable at the distances specified at and above a height of 1,000 feet above the elevation of the threshold, or the lowest altitude authorized for transition, whichever is higher. Such signals must be receivable, to the distances specified, up to a surface extending outward from the SDF antenna and inclined at 7° above the horizontal.

(7) The modulation tones must be phase-locked so that within the half course sector, the demodulated 90 Hz and 150 Hz wave forms pass through zero in the same direction within 20° of phase relative to the 150 Hz component, every half cycle of the combined 90 Hz

and 150 Hz wave form. However, the phase need not be measured within the half course sector.

(8) The angle of convergence of the final approach course and the extended runway centerline must not exceed 30°. The final approach course must be aligned to intersect the extended runway centerline between points A1 and the runway threshold. When an operational advantage can be achieved, a final approach course that does not intersect the runway or that intersects it at a distance greater than point A1 from the threshold, may be established, if that course lies within 500 feet laterally of the extended runway centerline at a point 3,000 feet outward from the runway threshold. The mean course line must be maintained within ±10 percent of the course sector width.

(9) The nominal displacement sensitivity within the half course sector must be 50 microamperes/degree. The nominal course sector width must be 6°. When an operational advantage can be achieved, a nominal displacement sensitivity of 25 microamperes/degree may be established, with a nominal course sector width of 12° with proportional displacement sensitivity. The lateral displacement sensitivity must be adjusted and maintained within the limits of plus or minus 17 percent of the nominal value.

(10) The off-course (clearance) signal must increase at a substantially linear rate with respect to the angular displacement from the course line up to an angle on either side of the course line where 175 microamperes of deflection is obtained. From that angle to ±10°, the off-course deflection must not be less than 175 microamperes. From ±10° to ±35° the off-course deflection must not be less than 150 microamperes. With the course adjusted to cause any of several monitor alarm conditions, the aforementioned values of 175 microamperes in the sector 10° each side of course and 150 microamperes in the sector ±10° to ±35° may be reduced to 160 microamperes and 135 microamperes, respectively. These conditions must be met at a distance of 18 nautical miles from the SDF antenna within the sector 10° each side of course line and 10 nautical miles from

the SDF antenna within the sector ±10° to ±35° each side of course line.

(11) The SDF may provide a ground-to-air radiotelephone communication channel to be operated simultaneously with the navigation and identification signals, if that operation does not interfere with the basic function. If a channel is provided, it must conform with the following standards:

(i) The channel must be on the same radio frequency carrier or carriers as used for the SDF function, and the radiation must be horizontally polarized. Where two carriers are modulated with speech, the relative phases of the modulations on the two carriers must avoid the occurrence of nulls within the coverage of the SDF.

(ii) On centerline, the peak modulation depth of the carrier or carriers due to the radiotelephone communications must not exceed 50 percent but must be adjusted so that the ratio of peak modulation depth due to the radiotelephone communications to that due to the identification signal is approximately 9:1.

(iii) The audio frequency characteristics of the radiotelephone channel must be flat to within 3 db relative to the level at 1,000 Hz over the range from 300 Hz to 3,000 Hz.

(12)(i) The SDF must provide for the simultaneous transmission of an identification signal, specific to the runway and approach direction, on the same radio frequency carrier or carriers as used for the SDF function. The transmission of the identification signal must not interfere in any way with the basic SDF function.

(ii) The identification signal must be produced by Class A2 modulation of the radio frequency carrier or carriers using a modulation tone of 1020 Hz within ±50 Hz. The depth of modulation must be between the limits of 5 and 15 percent except that, where a radiotelephone communication channel is provided, the depth of modulation must be adjusted so that the ratio of peak modulation depth due to radiotelephone communications to that due to the identification signal modulation is approximately 9:1. The emissions carrying the identification signal must be horizontally polarized.

(iii) The identification signal must employ the International Morse Code and consist of three letters.

(iv) The identification signal must be transmitted at a speed corresponding to approximately seven words per minute, and must be repeated at approximately equal intervals, not less than six times per minute. When SDF transmission is not available for operational use, including periods of removal of navigational components or during maintenance or test transmissions, the identification signal must be suppressed.

(b) It must be shown during ground inspection of the design features of the equipment that there will not be conditions that will allow unsafe operations because of component failure or deterioration.

(c) The monitor must be checked periodically during the in-service test evaluation period for calibration and stability. These tests, and ground checks of SDF radiation characteristics must be conducted in accordance with the maintenance manual required by § 171.115(c) and must meet the standards and tolerances contained in § 171.111(j).

(d) The monitor system must provide a warning to the designated control point(s) when any of the conditions of § 171.111(j) occur, within the time periods specified in that paragraph.

(e) Flight inspection to determine the adequacy of the facility's operational performance and compliance with applicable performance requirements must be conducted in accordance with the "U.S. Standard Flight Inspection Manual." Tolerances contained in the U.S. Standard Flight Inspection Manual, section 217, must be complied with except as stated in paragraph (f) of this section.

(f) Flight inspection tolerances specified in section 217 of the "U.S. Standard Flight Inspection Manual" must be complied with except as follows:

(1) *Course sector width.* The nominal course sector width must be 6°. When an operational advantage can be achieved, a nominal course sector width of 12° may be established. Course sector width must be adjusted and maintained within the limits of ±17 percent of the nominal value.

(2) *Course alignment.* The mean course line must be adjusted and maintained within the limits of ±10 percent of the nominal course sector width.

(3) *Course structure.* Course deviations due to roughness, scalloping, or bends must be within the following limitations:

(i) *Front course.* (a) Course structure from 18 miles from runway threshold to Point A must not exceed ±40 microamperes;

(b) Point A to Point A-1—linear decrease from not more than ±40 microamperes at Point A to not more than ±20 microamperes at Point A-1;

(c) Point A-1 to Missed Approach Point—not more than ±20 microamperes;

(d) Monitor tolerances: width ±17 percent of nominal; alignment—±10 percent of nominal course sector width.

(ii) *Back course.* (a) Course structure 18 miles from runway threshold to 4 miles from runway threshold must not exceed ±40 microamperes. Four miles to 1 mile from R/W must not exceed ±40 microamperes decreasing to not more than ±20 microamperes, at a linear rate.

(b) Monitor tolerances: width—±17 percent of nominal; alignment—±10 percent of nominal course sector width.

[Doc. No. 10116, 35 FR 12711, Aug. 11, 1970, as amended by Amdt. 171-9, 38 FR 28557, Oct. 15, 1973]

§ 171.111 Ground standards and tolerances.

Compliance with this section must be shown as a condition to approval and must be maintained during operation of the SDF.

(a) *Frequency.* (1) The SDF must operate on odd tenths or odd tenths plus a twentieth MHz within the frequency band 108.1 MHz to 111.95 MHz. The frequency tolerance of the radio frequency carrier must not exceed plus or minus 0.002 percent.

(2) The modulating tones must be 90 Hz and 150 Hz within ±2.5 percent.

(3) The identification signal must be 1020 Hz within ±50 Hz.

(4) The total harmonic content of the 90 Hz tone must not exceed 10 percent.

(5) The total harmonic content of the 150 Hz tone must not exceed 10 percent.

(b) *Power output.* The normal carrier power output must be of a value which will provide coverage requirements of § 171.109(a)(6) when reduced by 3 dB to the monitor RF power reduction alarm point specified in § 171.111(j)(3).

(c) *VSWR.* (1) The VSWR of carrier and sideband feedlines must be a nominal value of 1/1 and must not exceed 1.2/1.

(2) The sponsor will also provide additional manufacturer's ground standards and tolerances for all VSWR parameters peculiar to the equipment which can effect performance of the facility in meeting the requirements specified in §§ 171.109 and 171.111.

(d) *Insulation resistance.* The insulation resistance of all coaxial feedlines must be greater than 20 megohms.

(e) *Depth of modulation.* (1) The depth of modulation of the radio frequency carrier due to each of the 90 Hz and 150 Hz tones must be 20 percent \pm 2 percent along the course line.

(2) The depth of modulation of the radio frequency carrier due to the 1020 Hz identification signal must be within 5 percent to 15 percent.

(f) *Course sector width.* The standard course sector width must be 6° or 12°. The course sector must be maintained with \pm 17 percent of the standard.

(g) *Course alignment.* Course alignment must be as specified in § 171.109(a)(8).

(h) *Back course alignment and width.* If a back course is provided, standards and tolerances for back course sector width and alignment must be the same as course sector width and course alignment specified in paragraphs (f) and (g) of this section.

(i) *Clearance.* Clearance must be as specified in § 171.109(a)(10).

(j) *Monitor standards and tolerances.* (1) The monitor system must provide a warning to the designated control point(s) when any of the conditions described in this paragraph occur, within the time periods specified in paragraph (j)(6) of this section.

(2) Course shift alarm: The monitor must alarm and cause radiation to cease, or identification and navigation signals must be removed, if the course alignment deviates from standard alignment by 10 percent or more of the standard course sector width.

(3) RF power reduction alarm: The monitor must alarm and cause radiation to cease, or identification and navigation signals must be removed, if the output power is reduced by 3 db or more from normal.

(4) Modulation level alarm: The monitor must alarm and cause radiation to cease, or identification and navigation signals must be removed, if the 90 Hz and 150 Hz modulation levels decrease by 17 percent or more.

(5) Course sector width alarm: The monitor must alarm and cause radiation to cease, or identification and navigation signals must be removed, for a change in course sector width to a value differing by \pm 17 percent or more from the standard.

(6) Monitor delay before shutdown: Radiation must cease, or identification and navigation signals must be removed, within 10 seconds after a fault is detected by the monitor, and no attempt must be made to resume radiation for a period of at least 20 seconds. If an automatic recycle device is used, not more than three successive recycles may be permitted before a complete SDF shutdown occurs.

(k) *Mean time between failures.* The mean time between failures must not be less than 800 hours. This measure is applied only to equipment failures (monitor or transmitting equipment, including out of tolerance conditions) which result in facility shutdown. It does not relate to the responsiveness of the maintenance organization.

(1) *Course alignment stability.* Drift of the course alignment must not exceed one-half the monitor limit in a 1-week period.

[Doc. No. 10116, 35 FR 12711, Aug. 11, 1970, as amended by Amdt. 171-9, 38 FR 28558, Oct. 15, 1973]

§ 171.113 Installation requirements.

(a) The facility must be installed according to accepted good engineering practices, applicable electric and safety codes, and FCC requirements.

(b) The SDF facility must have the following basic components:

(1) VHF SDF equipment and associated monitor system;

(2) Remote control, and indicator equipment (remote monitor) when required by the FAA;

(3) A final approach fix; and

(4) Compass locator (COMLO) or marker if suitable fixes and initial approach routes are not available from existing facilities.

(c) The facility must have a reliable source of suitable primary power, either from a power distribution system or locally generated. Also, adequate power capacity must be provided for operation of test and working equipment at the SDF. A determination by the Federal Aviation Administration as to whether a facility will be required to have standby power for the SDF and monitor accessories to supplement the primary power will be made for each airport based upon operational minimums and density of air traffic.

(d) A determination by the Federal Aviation Administration as to whether a facility will be required to have dual transmitting equipment with automatic changeover for the SDF will be made for each airport based upon operational minimums and density of air traffic.

(e) There must be a means for determining, from the ground, the performance of the equipment (including antennae), initially and periodically.

(f) The facility must have the following ground-air or landline communication services:

(1) At facilities outside of and not immediately adjacent to controlled airspace, there must be ground-air communications from the airport served by the facility. The utilization of voice on the SDF should be determined by the facility operator on an individual basis.

(2) At facilities within or immediately adjacent to controlled airspace, there must be ground/air communications required by paragraph (b)(1) of this section and reliable communications (at least a landline telephone) from the airport to the nearest Federal Aviation Administration air traffic control or communications facility.

Compliance with paragraphs (f) (1) and (2) of this section need not be shown at airports where an adjacent Federal Aviation Administration facility can communicate with aircraft on the ground at the airport and during the entire proposed instrument approach procedure. In addition, at low traffic density airports within or immediately

adjacent to controlled airspace, and where extensive delays are not a factor, the requirements of paragraphs (f) (1) and (2) of this section may be reduced to reliable communications (at least a landline telephone) from the airport to the nearest Federal Aviation Administration air traffic control or communications facility, if an adjacent Federal Aviation Administration facility can communicate with aircraft during the proposed instrument approach procedure down to the airport surface or at least down to the minimum approach altitude.

(g) At those locations where two separate SDF facilities serve opposite ends of a single runway, an interlock must insure that only the facility serving the approach direction in use can radiate, except where no operationally harmful interference results.

(h) At those locations where, in order to alleviate frequency congestion, the SDF facilities serving opposite ends of one runway employ identical frequencies, an interlock must insure that the facility not in operational use cannot radiate.

(i) Provisions for maintenance and operations by authorized persons only.

(j) Where an operational advantage exists, the installation may omit a back course.

[Doc. No. 10116, 35 FR 12711, Aug. 11, 1970, as amended by Amdt. 171-16, 56 FR 65664, Dec. 17, 1991]

§ 171.115 Maintenance and operations requirements.

(a) The owner of the facility shall establish an adequate maintenance system and provide qualified maintenance personnel to maintain the facility at the level attained at the time it was commissioned. Each person who maintains a facility shall meet at a minimum the Federal Communications Commission's licensing requirements and show that he has the special knowledge and skills needed to maintain the facility, including proficiency in maintenance procedures and the use of specialized test equipment.

(b) The SDF must be designed and maintained so that the probability of operation within the performance requirements specified is high enough to insure an adequate level of safety. In

the event out-of-tolerance conditions develop, the facility shall be removed from operation, and the designated control point notified.

(c) The owner must prepare, and obtain approval of, and each person operating or maintaining the facility shall comply with, an operations and maintenance manual that sets forth procedures for operations, preventive maintenance, and emergency maintenance, including instructions on each of the following:

(1) Physical security of the facility. This includes provisions for designating critical areas relative to the facility and preventing or controlling movements within the facility that may adversely affect SDF operations.

(2) Maintenance and operations by authorized persons only.

(3) Federal Communications Commission requirements for operating personnel and maintenance personnel.

(4) Posting of licenses and signs.

(5) Relation between the facility and Federal Aviation Administration air traffic control facilities, with a description of the boundaries of controlled airspace over or near the facility, instructions for relaying air traffic control instructions and information (if applicable), and instructions for the operation of an air traffic advisory service if the facility is located outside of controlled airspace.

(6) Notice to the Administrator of any suspension of service.

(7) Detailed and specific maintenance procedures and servicing guides stating the frequency of servicing.

(8) Air-ground communications, if provided, expressly written or incorporating appropriate sections of Federal Aviation Administration manuals by reference.

(9) Keeping of station logs and other technical reports, and the submission of reports required by § 171.117.

(10) Monitoring of the facility.

(11) Names, addresses, and telephone numbers of persons to be notified in an emergency.

(12) Inspection by U.S. personnel.

(13) Shutdowns for routine maintenance and issue of "Notices to Airmen" for routine or emergency shutdowns, except that private use facilities may omit "Notices to Airmen."

(14) Commissioning of the facility.

(15) An acceptable procedure for amending or revising the manual.

(16) An explanation of the kinds of activities (such as construction or grading) in the vicinity of the facility that may require shutdown or certification of the facility by Federal Aviation Administration flight check.

(17) Procedure for conducting a ground check of SDF course alignment, width and clearance.

(18) The following information concerning the facility:

(i) Facility component locations with respect to airport layout, instrument runway, and similar areas;

(ii) The type, make, and model of the basic radio equipment that will provide the service;

(iii) The station power emission and frequencies of the SDF, markers and associated COMLOs, if any;

(iv) The hours of operation;

(v) Station identification call letters and method of station identification and the time spacing of the identification;

(vi) A description of the critical parts that may not be changed, adjusted, or repaired without a Federal Aviation Administration flight check to confirm published operations.

(d) The owner shall make a ground check of the facility each month in accordance with procedures approved by the Federal Aviation Administration at the time of commissioning, and shall report the results of the checks as provided in § 171.117.

(e) If the owner desires to modify the facility, he shall submit the proposal to the Federal Aviation Administration and may not allow any modifications to be made without specific approval.

(f) The owner's maintenance personnel shall participate in initial inspections made by the Federal Aviation Administration. In the case of subsequent inspections, the owner or his representatives shall participate.

(g) Whenever it is required by the Federal Aviation Administration, the owner shall incorporate improvements in SDF maintenance. In addition, he shall provide a stock of spare parts, of such a quantity, to make possible the

§ 171.117

prompt replacement of components that fail or deteriorate in service.

(h) The owner shall provide Federal Aviation Administration approved test instruments needed for maintenance of the facility.

(i) The owner shall close the facility by ceasing radiation and shall issue a "Notice to Airmen" that the facility is out of service (except that private use facilities may omit "Notices to Airmen"), upon receiving two successive pilot reports of its malfunctioning.

§ 171.117 Reports.

The owner of each facility to which this subpart applies shall make the following reports, at the time indicated, to the Federal Aviation Administration Regional Office for the area in which the facility is located:

(a) Record of meter readings and adjustments (Form FAA-198). To be filled out by the owner or his maintenance representative with the equipment adjustments and meter readings as of the time of commissioning, with one copy to be kept in the permanent records of the facility and two copies to the appropriate Regional Office of the Federal Aviation Administration. The owner shall revise the form after any major repair, modification, or retuning, to reflect an accurate record of facility operation and adjustment.

(b) Facility maintenance log (FAA Form 6030-1) This form is a permanent record of all equipment malfunctioning met in maintaining the facility, including information on the kind of work and adjustments made, equipment failures, causes (if determined), and corrective action taken. The owner shall keep the original of each report at the facility and send a copy to the appropriate Regional Office of the Federal Aviation Administration at the end of each month in which it is prepared.

(c) Radio equipment operation record (Form FAA-418), containing a complete record of meter readings, recorded on each scheduled visit to the facility. The owner shall keep the original of each month's record at the facility and send a copy of it to the appropriate Re-

14 CFR Ch. I (1-1-24 Edition)

gional Office of the Federal Aviation Administration.

[Doc. No. 10116, 35 FR 12711, Aug. 11, 1970, as amended by Amdt. 171-10, 40 FR 36110, Aug. 19, 1975]

Subpart G—Distance Measuring Equipment (DME)

SOURCE: Docket No. 10116, 35 FR 12715, Aug. 11, 1970, unless otherwise noted.

§ 171.151 Scope.

This subpart sets forth minimum requirements for the approval and operation of non-Federal DME facilities that are to be involved in the approval of instrument flight rules and air traffic control procedures related to those facilities.

§ 171.153 Requests for IFR procedure.

(a) Each person who requests an IFR procedure based on a DME facility that he owns must submit the following information with that request:

(1) A description of the facility and evidence that the equipment meets the performance requirements of §171.157 and is installed in accordance with §171.159.

(2) A proposed procedure for operating the facility.

(3) A proposed maintenance organization and maintenance manual that meets the requirement of §171.161.

(4) A statement of intention to meet the requirements of this subpart.

(5) A showing that the facility has an acceptable level of operational reliability and an acceptable standard of performance. Previous equivalent operational experience with a facility with identical design and operational characteristics will be considered in showing compliance with this paragraph.

(b) After the Federal Aviation Administration inspects and evaluates the facility, it advises the owner of the results and of any required changes in the facility or the maintenance manual or maintenance organization. The owner must then correct the deficiencies, if any, and operate the facility for an in-service evaluation by the Federal Aviation Administration.

§ 171.155 Minimum requirements for approval.

(a) The following are the minimum requirements that must be met before the Federal Aviation Administration will approve an IFR procedure for a non-Federal DME:

(1) A suitable frequency channel must be available.

(2) The facility's performance, as determined by air and ground inspection, must meet the requirements of § 171.157.

(3) The installation of the equipment must meet the requirements of § 171.159.

(4) The owner must agree to operate and maintain the facility in accordance with § 171.161.

(5) The owner must agree to furnish periodic reports, as set forth in § 171.163, and must agree to allow the Federal Aviation Administration to inspect the facility and its operation whenever necessary.

(6) The owner must assure the Federal Aviation Administration that he will not withdraw the facility from service without the permission of the Federal Aviation Administration.

(7) The owner must bear all costs of meeting the requirements of this section and of any flight or ground inspections made before the facility is commissioned, except that the Federal Aviation Administration may bear certain of these costs subject to budgetary limitations and policy established by the Administrator.

(b) If the applicant for approval meets the requirements of paragraph (a) of this section, the Federal Aviation Administration commissions the facility as a prerequisite to its approval for use in an IFR procedure. The approval is withdrawn at any time the facility does not continue to meet those requirements.

§ 171.157 Performance requirements.

(a) The DME must meet the performance requirements set forth in the "International Standards and Recommended Practices, Aeronautical Telecommunications, Part I, Paragraph 3.5" (Annex 10 to the Convention of International Civil Aviation).

(b) It must be shown during ground inspection of the design features of the

equipment that there will not be conditions that will allow unsafe operations because of component failure or deterioration.

(c) The monitor must be checked periodically, during the in-service test evaluation period, for calibration and stability. These tests and ground tests of the functional and performance characteristics of the DME transponder must be conducted in accordance with the maintenance manual required by § 171.161(b).

(d) Flight inspection to determine the adequacy of the facility's operational performance and compliance with applicable "Standards and Recommended Practices" must be accomplished in accordance with the "U.S. Standard Flight Inspection Manual."

[Doc. No. 10116, 35 FR 12715, Aug. 11, 1970, as amended by Amdt. 171-13, 50 FR 4875, Nov. 27, 1985]

§ 171.159 Installation requirements.

(a) The facility must be installed according to accepted good engineering practices, applicable electric and safety codes, and Federal Communications Commission requirements.

(b) The facility must have a reliable source of suitable primary power, either from a power distribution system or locally generated, with a supplemental standby system, if needed.

(c) Dual transmitting equipment with automatic changeover is preferred and may be required to support certain IFR procedures.

(d) There must be a means for determining from the ground, the performance of the equipment, initially and periodically.

(e) A facility intended for use as an instrument approach aid for an airport must have or be supplemented by the following ground air or landline communications services:

(1) At facilities outside of and not immediately adjacent to controlled airspace, there must be ground-air communications from the airport served by the facility. Separate communications channels are acceptable.

(2) At facilities within or immediately adjacent to controlled airspace, there must be the ground-air communications required by paragraph (e)(1)

§ 171.161

14 CFR Ch. I (1-1-24 Edition)

of this section and reliable communications (at least a landline telephone) from the airport to the nearest Federal Aviation Administration air traffic control or communications facility. Separate communications channels are acceptable.

Compliance with paragraphs (e) (1) and (2) of this section need not be shown at airports where an adjacent Federal Aviation Administration facility can communicate with aircraft on the ground at the airport and during the entire proposed instrument approach procedure. In addition, at low traffic density airports within or immediately adjacent to controlled airspace, and where extensive delays are not a factor, the requirements of paragraphs (e) (1) and (2) of this section may be reduced to reliable communications (at least a landline telephone) from the airport to the nearest Federal Aviation Administration air traffic control or communications facility, if an adjacent Federal Aviation Administration facility can communicate with aircraft during the proposed instrument approach procedure, at least down to the minimum en route altitude for the controlled airspace area.

[Doc. No. 10116, 35 FR 12715, Aug. 11, 1970, as amended by Amdt. 171-16, 56 FR 65665, Dec. 17, 1991]

§ 171.161 Maintenance and operations requirements.

(a) The owner of the facility shall establish an adequate maintenance system and provide qualified maintenance personnel to maintain the facility at the level attained at the time it was commissioned. Each person who maintains a facility shall meet at a minimum the Federal Communications Commission's licensing requirements and show that he has the special knowledge and skills needed to maintain the facility, including proficiency in maintenance procedures and the use of specialized test equipment.

(b) The owner must prepare and obtain Federal Aviation Administration approval of, and each person operating or maintaining the facility shall comply with, an operations and maintenance manual that sets forth procedures for operations, preventive maintenance, and emergency maintenance,

including instructions on each of the following:

- (1) Physical security of the facility.
- (2) Maintenance and operations by authorized persons only.
- (3) Federal Communications Commission's requirements and maintenance personnel.
- (4) Posting of licenses and signs.
- (5) Relations between the facility and Federal Aviation Administration air traffic control facilities, with a description of the boundaries of controlled airspace over or near the facility, instructions for relaying air traffic control instructions and information (if applicable), and instructions for the operation of an air traffic advisory service if the DME is located outside of controlled airspace.
- (6) Notice to the Administrator of any suspension of service.
- (7) Detailed and specific maintenance procedures and servicing guides stating the frequency of servicing.
- (8) Air-ground communications, if provided, expressly written or incorporating appropriate sections of Federal Aviation Administration manuals by reference.
- (9) Keeping of station logs and other technical reports, and the submission of reports required by § 171.163.
- (10) Monitoring of the facility.
- (11) Inspections by U.S. personnel.
- (12) Names, addresses, and telephone numbers of persons to be notified in an emergency.
- (13) Shutdowns for routine maintenance and issue of "Notices to Airmen" for routine or emergency shutdowns, except that private use facilities may omit the "Notices to Airmen."
- (14) An explanation of the kinds of activity (such as construction or grading) in the vicinity of the facility that may require shutdown or reapproval of the facility by Federal Aviation Administration flight check.
- (15) Commissioning of the facility.
- (16) An acceptable procedure for amending or revising the manual.
- (17) The following information concerning the facility:
 - (i) Location by latitude and longitude to the nearest second, and its position with respect to airport layouts.

(ii) The type, make, and model of the basic radio equipment that will provide the service.

(iii) The station power emission and frequency.

(iv) The hours of operation.

(v) Station identification call letters and methods of station identification, whether by Morse code or recorded voice announcement, and the time spacing of the identification.

(vi) A description of the critical parts that may not be changed, adjusted, or repaired without an FAA flight check to confirm published operations.

(c) The owner shall make a monthly ground operational check in accordance with procedures approved by the FAA at the time of commissioning, and shall report the results of the checks as provided in § 171.163.

(d) If the owner desires to modify the facility, he shall submit the proposal to the FAA and may not allow any modifications to be made without specific approval.

(e) The owner's maintenance personnel shall participate in initial inspections made by the FAA. In the case of subsequent inspections, the owner or his representative shall participate.

(f) Whenever it is required by the FAA, the owner shall incorporate improvements in DME maintenance.

(g) The owner shall provide a stock of spare parts of such a quantity to make possible the prompt replacement of components that fail or deteriorate in service.

(h) The owner shall provide FAA-approved test instruments needed for maintenance of the facility.

(i) The owner shall shut down the facility (*i.e.*, cease radiation and issue a NOTAM that the facility is out-of-service) upon receiving two successive pilot reports of its malfunctioning.

§ 171.163 Reports.

The owner of each facility to which this subpart applies shall make the following reports on forms furnished by the FAA, at the time indicated, to the FAA Regional office for the area in which the facility is located:

(a) Record of meter readings and adjustments (Form FAA-198). To be filled out by the owner with the equipment adjustments and meter readings as of

the time of commissioning, with one copy to be kept in the permanent records of the facility and two copies to the appropriate Regional office of the FAA. The owner shall revise the form after any major repair, modification, or returning, to reflect an accurate record of facility operation and adjustment.

(b) Facility maintenance log (FAA Form 6030-1). This form is a permanent record of all equipment malfunctioning met in maintaining the facility, including information on the kind of work and adjustments made, equipment failures, causes (if determined), and corrective action taken. The owner shall keep the original of each report at the facility and send a copy to the appropriate Regional Office of the Federal Aviation Administration at the end of the month in which it is prepared.

(c) Radio equipment operation record (Form FAA-418), containing a complete record of meter readings, recorded on each scheduled visit to the facility. The owner shall keep the original of each month's record at the facility and send a copy of it to the appropriate Regional Office of the Federal Aviation Administration.

[Doc. No. 10116, 35 FR 12715, Aug. 11, 1970, as amended by Amdt. 171-10, 40 FR 36110, Aug. 19, 1975]

Subpart H—VHF Marker Beacons

SOURCE: Docket No. 10116, 35 FR 12716, Aug. 11, 1970, unless otherwise noted.

§ 171.201 Scope.

(a) This subpart sets forth minimum requirements for the approval and operation of non-Federal VHF marker beacon facilities that are to be involved in the approval of instrument flight rules and air traffic control procedures related to those facilities.

(b) [Reserved]

§ 171.203 Requests for IFR procedure.

(a) Each person who requests an IFR procedure which will incorporate the use of a VHF marker beacon facility that he owns must submit the following information with that request:

§ 171.205

(1) A description of the facility and evidence that the equipment meets the performance requirements of §171.207 and is installed in accordance with §171.209.

(2) A proposed procedure for operating the facility.

(3) A proposed maintenance organization and a maintenance manual that meets the requirements of §171.211.

(4) A statement of intent to meet the requirement of this subpart.

(5) A showing that the facility has an acceptable level of operational reliability, and an acceptable standard of performance. Previous equivalent operational experience may be shown to comply with this subparagraph.

(b) After the Federal Aviation Administration inspects and evaluates the facility, it advises the owner of the results and of any required changes in the facility or the maintenance manual or maintenance organization. The owner shall then correct the deficiencies, if any, and operate the facility for an in-service evaluation by the Federal Aviation Administration.

§ 171.205 Minimum requirements for approval.

(a) The following are the minimum requirements that must be met before the Federal Aviation Administration will approve an IFR procedure which incorporates the use of a non-Federal VHF marker beacon facility under this subpart:

(1) The facility's performances, as determined by air and ground inspection, must meet the requirements of §171.207.

(2) The installation of the equipment must meet the requirements of §171.209.

(3) The owner must agree to operate and maintain the facility in accordance with §171.211.

(4) The owner must agree to furnish periodic reports, as set forth in §171.213, and agree to allow the Federal Aviation Administration to inspect the facility and its operation whenever necessary.

(5) The owner must assure the Federal Aviation Administration that he will not withdraw the facility from service without the permission of the Federal Aviation Administration.

14 CFR Ch. I (1-1-24 Edition)

(6) The owner must bear all costs of meeting the requirements of this section and of any flight or ground inspections made before the facility is commissioned, except that the Federal Aviation Administration may bear certain of these costs subject to budgetary limitations and policy established by the Administrator.

(b) If the applicant for approval meets the requirements of paragraph (a) of this section, the Federal Aviation Administration commissions the facility as a prerequisite to its approval for use in an IFR procedure. The approval is withdrawn at any time the facility does not continue to meet those requirements.

§ 171.207 Performance requirements.

(a) VHF Marker Beacons must meet the performance requirements set forth in the "International Standards and Recommended Practices, Aeronautical Telecommunications, Part I, paragraphs 3.1.6 and 3.6." (Annex 10 to the Convention on International Civil Aviation) except those portions that pertain to identification. Identification of a marker beacon (75 MHz) must be in accordance with "U.S. Standard Flight Inspection Manual," §219.

(b) The facility must perform in accordance with recognized and accepted good electronic engineering practices for the desired service. The facility must be checked periodically during the in-service test evaluation period for calibration and stability. These tests and ground tests of the marker radiation characteristics must be conducted in accordance with the maintenance manual required by §171.211(b).

(c) It must be shown during ground inspection of the design features of the equipment that there will not be conditions that will allow unsafe operations because of component failure or deterioration.

(d) Flight inspection to determine the adequacy of the facility's operational performance and compliance with applicable "Standards and Recommended Practices" are conducted in accordance with the "U.S. Standard Flight Inspection Manual." The original test is made by the Federal Aviation Administration and later tests

must be made under arrangements, satisfactory to the Federal Aviation Administration, that are made by the owner.

§ 171.209 Installation requirements.

(a) The facility must be installed according to accepted good engineering practices, applicable electric and safety codes, and Federal Communications Commission requirements.

(b) The facility must have a reliable source of suitable primary power.

(c) Dual transmitting equipment may be required, if applicable, to support certain IFR procedures.

(d) At facilities within or immediately adjacent to controlled airspace and that are intended for use as instrument approach aids for an airport, there must be ground-air communications or reliable communications (at least a landline telephone) from the airport to the nearest Federal Aviation Administration air traffic control or communication facility. Compliance with this paragraph need not be shown at airports where an adjacent Federal Aviation Administration facility can communicate with aircraft on the ground at the airport and during the entire proposed instrument approach procedure. In addition, at low traffic density airports within or immediately adjacent to controlled airspace, and where extensive delays are not a factor, the requirements of this paragraph may be reduced to reliable communications (at least a landline telephone) from the airport to the nearest Federal Aviation Administration air traffic control or communications facility, if an adjacent Federal Aviation Administration facility can communicate with aircraft during the proposed instrument approach procedure, at least down to the minimum en route altitude for the controlled airspace area.

[Doc. No. 10116, 35 FR 12716, Aug. 11, 1970, as amended by Amdt. 171-16, 56 FR 65665, Dec. 17, 1991]

§ 171.211 Maintenance and operations requirements.

(a) The owner of the facility shall establish an adequate maintenance system and provide qualified maintenance personnel to maintain the facility at the level attained at the time it was

commissioned. Each person who maintains a facility shall meet at a minimum the Federal Communications Commission's licensing requirements and show that he has the special knowledge and skills needed to maintain the facility, including proficiency in maintenance procedures and the use of specialized test equipment.

(b) The owner must prepare, and obtain approval of, and each person who operates or maintains the facility shall comply with, an operations and maintenance manual that sets forth procedures for operations, preventive maintenance, and emergency maintenance, including instructions on each of the following:

- (1) Physical security of the facility.
- (2) Maintenance and operations by authorized persons only.
- (3) Federal Communications Commission's requirements for operating and maintenance personnel.
- (4) Posting of licenses and signs.
- (5) Relations between the facility and Federal Aviation Administration air traffic control facilities, with a description of the boundaries of controlled airspace over or near the facility, instructions for relaying air traffic control instructions and information (if applicable).
- (6) Notice to the Administrator of any suspension of service.
- (7) Detailed arrangements for maintenance, flight inspection, and servicing, stating the frequency of servicing.
- (8) Keeping of station logs and other technical reports, and the submission of reports required by § 171.213.
- (9) Monitoring of the facility, at least once each half hour, to assure continuous operation.
- (10) Inspections by U.S. personnel.
- (11) Names, addresses, and telephone numbers of persons to be notified in an emergency.
- (12) Shutdowns for routine maintenance and issue of "Notices to Airmen" for routine or emergency shutdowns (private use facilities may omit the "Notice to Airmen").
- (13) Commissioning of the facility.
- (14) An acceptable procedure for amending or revising the manual.
- (15) The following information concerning the facility:

§ 171.213

(i) Location by latitude and longitude to the nearest second, and its position with respect to airport layouts.

(ii) The type, make, and model of the basic radio equipment that will provide the service.

(iii) The station power emission and frequency.

(iv) The hours of operation.

(v) Station identification call letters and methods of station identification, whether by Morse Code or recorded voice announcement, and the time spacing of the identification.

(c) If the owner desires to modify the facility, he shall submit the proposal to the Federal Aviation Administration and meet applicable requirements of the Federal Communications Commission, and must not allow any modification to be made without specific approval by the Federal Aviation Administration.

(d) The owner's maintenance personnel shall participate in initial inspections made by the Federal Aviation Administration. In the case of subsequent inspections, the owner or his representative shall participate.

(e) The owner shall provide a stock of spare parts, of such a quantity to make possible the prompt replacement of components that fail or deteriorate in service.

(f) The owner shall shut down the facility by ceasing radiation, and shall issue a "Notice to Airmen" that the facility is out of service (except that private use facilities may omit "Notices to Airmen") upon receiving two successive pilot reports of its malfunctioning.

§ 171.213 Reports.

The owner of each facility to which this subpart applies shall make the following reports, at the times indicated, to the Federal Aviation Administration Regional Office for the area in which the facility is located:

(a) Record of meter readings and adjustments (Form FAA-198). To be filled out by the owner or his maintenance representative with the equipment adjustments and meter readings as of the time of commissioning, with one copy to be kept in the permanent records of the facility and two copies to the appropriate Regional Office of the Fed-

14 CFR Ch. I (1-1-24 Edition)

eral Aviation Administration. The owner must revise the form after any major repair, modification, or retuning, to reflect an accurate record of facility operation and adjustment.

(b) Facility maintenance log (FAA Form 6030-1). This form is a permanent record of all equipment malfunctioning met in maintaining the facility, including information on the kind of work and adjustments made, equipment failures, causes (if determined), and corrective action taken. The owner shall keep the original of each report at the facility and send a copy to the appropriate Regional Office of the Federal Aviation Administration at the end of the month in which it is prepared.

(c) Radio equipment operation record (Form FAA-418), containing a complete record of meter readings, recorded on each scheduled visit to the facility. The owner shall keep the original of each month's record at the facility and send a copy of it to the appropriate Regional Office of the Federal Aviation Administration.

[Doc. No. 10116, 35 FR 12716, Aug. 11, 1970, as amended by Amdt. 171-10, 40 FR 36110, Aug. 19, 1975]

Subpart I—Interim Standard Microwave Landing System (ISMLS)

SOURCE: Docket No. 14120, 40 FR 36110, Aug. 19, 1975, unless otherwise noted.

§ 171.251 Scope.

This subpart sets forth minimum requirements for the approval and operation of non-Federal Interim Standard Microwave Landing System (ISMLS) facilities that are to be involved in the approval of instrument flight rules and air traffic control procedures related to those facilities.

§ 171.253 Definitions.

As used in this subpart:

Angular displacement sensitivity (Glide Slope) means the ratio of measured DDM to the corresponding angular displacement from the appropriate reference line.

Collocated ground station means the type of ground station which transmits

two or more guidance signals simultaneously from a common location.

Course line means the locus of points nearest to the runway centerline in any horizontal plane at which the DDM is zero.

Course sector (full) means a sector in a horizontal plane containing the course line and limited by the loci of points nearest to the course line at which the DDM is 0.155.

Course sector (half) means the sector in a horizontal plane containing the course line and limited by the loci of points nearest to the course line at which DDM is 0.0775.

DDM means difference in depth of modulation. The percentage modulation depth of the larger signal minus the percentage modulation depth of the smaller signal, divided by 100.

Displacement sensitivity (Localizer) means the ratio of measured DDM to the corresponding lateral displacement from the appropriate reference line.

Facility Performance Category I—ISMLS means an ISMLS which provides guidance information from the coverage limit of the ISMLS to the point at which the localizer course line intersects the ISMLS glide path at a height of 200 feet or less above the horizontal plane containing the threshold.

Glide path means that locus of points in the vertical plane containing the runway center line at which the DDM is zero, which, of all such loci, is the closest to the horizontal plane.

Glide path angle (θ) means the angle between a straight line which represents the mean of the ISMLS glide path and the horizontal.

Glide path sector (full) means the sector in the vertical plane containing the ISMLS glide path and limited by the loci of points nearest to the glide path at which the DDM is 0.175. The ISMLS glide path sector is located in the vertical plane containing the runway centerline, and is divided by the radiated glide path in two parts called upper sector and lower sector, referring respectively to the sectors above and below the glide path.

Glide path sector (half) means the sector in the vertical plane containing the ISMLS glide path and limited by the loci of points nearest to the glide path at which the DDM is 0.0875.

ISMLS Point 'A' means an imaginary point on the glide path/localizer course measured along the runway centerline extended, in the approach direction, four nautical miles from the runway threshold.

ISMLS Point 'B' means an imaginary point on the glide path/localizer course measured along the runway centerline extended, in the approach direction, 3500 feet from the runway threshold.

ISMLS Point 'C' means a point through which the downward extended straight portion of the glide path (at the commissioned angle) passes at a height of 100 feet above the horizontal plane containing the runway threshold.

Interim standard microwave landing system (ISMLS) means a ground station which transmits azimuth and elevation angle information which, when decoded and processed by the airborne unit, provides signal performance capable of supporting approach minima for V/STOL and CTOL operations and operates with the signal format and tolerances specified in §§171.259, 171.261, 171.263, 171.265, and 171.267.

Integrity means that quality which relates to the trust which can be placed in the correctness of the information supplied by the facility.

Mean corrective time means the average time required to correct an equipment failure over a given period, after a service man reaches the facility.

Mean time between failures means the average time between equipment failure over a given period.

Reference datum means a point at a specified height located vertically above the intersection of the runway centerline and the threshold and through which the downward extended straight portion of the ISMLS glide path passes.

Split type ground station means the type of ground station in which the electronic components for the azimuth and elevation guidance are contained in separate housings or shelters at different locations, with the azimuth portion of the ground station located at the stop end of the runway, and the elevation guidance near the approach end of the runway.

§ 171.255

14 CFR Ch. I (1-1-24 Edition)

§ 171.255 Requests for IFR procedures.

(a) Each person who requests an IFR procedure based on an ISMLS facility that he owns must submit the following information with that request:

(1) A description of the facility and evidence that the equipment meets the performance requirements of §§171.259, 171.261, 171.263, 171.265, 171.267, and 171.269, and is installed in accordance with §171.271.

(2) A proposed procedure for operating the facility.

(3) A proposed maintenance organization and a maintenance manual that meets the requirements of §171.273.

(4) A statement of intent to meet the requirements of this subpart.

(5) A showing that the ISMLS facility has an acceptable level of operational reliability, maintainability and acceptable standard of performance. Previous equivalent operational experience with a facility with identical design and operational characteristics will be considered in showing compliance with this paragraph.

(b) After the FAA inspects and evaluates the ISMLS facility, it advises the owner of the results and of any required changes in the ISMLS facility or in the maintenance manual or maintenance organization. The owner must then correct the deficiencies, if any, and operate the ISMLS facility for an inservice evaluation by the FAA.

§ 171.257 Minimum requirements for approval.

(a) The following are the minimum requirements that must be met before the FAA approves an IFR procedure for a non-Federal ISMLS facility:

(1) The performance of the ISMLS facility, as determined by flight and ground inspection conducted by the FAA, must meet the requirements of §§171.259, 171.261, 171.263, 171.265, 171.267, and 171.269.

(2) The installation of the equipment must meet the requirements of §171.271.

(3) The owner must agree to operate and maintain the ISMLS facility in accordance with §171.273.

(4) The owner must agree to furnish periodic reports as set forth in §171.275 and agree to allow the FAA to inspect

the facility and its operation whenever necessary.

(5) The owner must assure the FAA that he will not withdraw the ISMLS facility from service without the permission of the FAA.

(6) The owner must bear all costs of meeting the requirements of this section and of any flight or ground inspection made before the ISMLS facility is commissioned, except that the FAA may bear certain costs subject to budgetary limitations and policy established by the Administrator.

(b) If the applicant for approval meets the requirements of paragraph (a) of this section, the FAA approves the ISMLS facility for use in an IFR procedure. The approval is withdrawn at any time that the ISMLS facility does not continue to meet those requirements. In addition, the ISMLS facility may be de-commissioned whenever the frequency channel is needed for higher priority common system service.

§ 171.259 Performance requirements: General.

(a) The ISMLS consists of the following basic components:

(1) C-Band (5000 MHz-5030 MHz) localizer equipment, associated monitor system, and remote indicator equipment;

(2) C-Band (5220 MHz-5250 MHz) glide path equipment, associated monitor system, and remote indicator equipment;

(3) VHF marker beacons (75 MHz), associated monitor systems, and remote indicator equipment.

(4) An ISMLS airborne receiver or a VHF/UHF ILS receiver modified to be capable of receiving the ISMLS signals. This modification requires the addition of a C-Band antenna, a converter unit, a microwave/ILS mode control, and a VHF/UHF receiver modification kit.

(b) The electronic ground equipments in paragraph (a)(1), (2), and (3) of this section, must be designed to operate on a nominal 120/240 volt, 60 Hz, 3-wire single phase AC power source.

(c) ISMLS ground equipment must meet the following service conditions:

(1) AC line parameters, DC voltage, elevation, and duty:

120 V nominal value, 102 V to 138 V (± 1 V).*

208 V nominal value, 177 V to 239 V (± 2 V).*

240 V nominal value, 204 V to 276 V (± 0.2 V).*

AC line frequency (60 Hz), 57 Hz to 63 Hz (± 0.2 Hz).*

DC voltage (48 V), 44 V to 52 V (± 0.5 V).*

*NOTE: Where discrete values of the above frequency or voltages are specified for testing purposes, the tolerances given in parentheses indicated by an asterisk apply to the test instruments used to measure these parameters.

Elevation, 0 to 10,000 ft. above sea level.

Duty, continuous, unattended.

(2) Ambient conditions for localizer and glide path equipment:

Temperature, -10 °C to $+50$ °C.

Relative humidity, 5% to 90%.

(3) Ambient conditions for marker beacon facilities and all other equipment installed outdoors (for example, antennae, field detectors, and shelters):

Temperature, -50 °C. to $+70$ °C.

Relative humidity, 5% to 100%.

(4) All equipment installed outdoors must operate satisfactorily under the following conditions:

Wind velocity, 0-100 MPH (not including gusts).

Hail stones, $\frac{1}{2}$ " diameter.

Rain, provide coverage through a distance of 5 nautical miles with rain falling at a rate of 50 millimeters per hour, and with rain falling at the rate of 25 millimeters per hour for the additional design performance range of the system.

Ice loading, encased in $\frac{1}{2}$ " radial thickness of clear ice.

(d) The ISMLS must perform in accordance with the following standards and practices for Facility Performance Category I operation:

(1) The ISMLS must be constructed and adjusted so that, at a specified distance from the threshold, similar instrumental indications in the aircraft represent similar displacements from the course line or ISMLS glide path, as appropriate, regardless of the particular ground installation in use.

(2) The localizer and glide path components listed in paragraphs (a)(1) and (a)(2) of this section which form part of an ISMLS, must comply at least with the standard performance requirements specified herein. The marker beacon components listed in paragraph (a)(3) of this section which form part of an ISMLS, must comply at least with the

standard performance requirements specified in subpart H of this part.

(3) The ISMLS must be so designed and maintained that the probability of operation is within the performance requirements specified in § 171.273(k).

(e) The signal format and pairing of the runway localizer and glide path transmitter frequencies of an ISMLS must be in accordance with the frequency plan approved by the FAA, and must meet the following signal format requirements:

(1) The localizer and glide slope stations must transmit angular guidance information on a C-band microwave carrier on narrow, scanned antenna beams that are encoded to produce a modulation in space which, after averaging over several beam scans, is equivalent to the modulation used for conventional ILS as specified in subpart C of this part, except that the frequency tolerance may not exceed ± 0.0001 percent.

(2) Guidance modulation must be impressed on the microwave carrier of the radiated signal in the form of a summation of 90 Hz and 150 Hz sinusoidal modulation corresponding to the pointing direction of the particular beam which radiates the signal.

(3) Each of the effective beam positions must be illuminated in a particular sequence for a short time interval. The modulation impressed on each beam must be a sample of the combined 90 Hz and 150 Hz waveform appropriate for that particular beam direction and time slot, and must be accomplished by appropriately varying the length of time the carrier is radiated during each beam illumination interval.

(4) For those cases where the scanning beam fills the coverage space in steps, the incremental step must not exceed 0.6 times the beam width where the beam is in the proportional guidance sector. In the clearance region, the step may not exceed 0.8 times the beam width.

(5) At least one pulse duration modulation (pdm) sample pulse per beam width of scan must be provided.

(6) The minimum pulse duration must be 40 microseconds.

(7) The minimum beam scan cycle must be 600 Hz.

(8) The minimum duty ratio detectable by a receiver located anywhere in the coverage areas defined by this specification may not be less than 0.1. Detected duty ratio means the ratio of the average energy per scan detected at a point in space to the average energy per scan transmitted in all directions through the transmitting antenna.

(9) The localizer must produce a C-band unmodulated reference frequency signal of sufficient strength to allow satisfactory operation of an aircraft receiver within the specified localizer and glide path coverage sectors. Pairing of this reference frequency with the localizer and glide slope frequencies must be in accordance with a frequency plan approved by the FAA.

§ 171.261 Localizer performance requirements.

This section prescribes the performance requirements for localizer equipment components of the ISMLS.

(a) The localizer antenna system must:

(1) Be located on the extension of the centerline of the runway at the stop end;

(2) Be adjusted so that the course line be on a vertical plane containing the centerline of the runway served;

(3) Have the minimum height necessary to comply with the coverage requirements prescribed in paragraph (j) of this section;

(4) Be located at a distance from the stop end of the runway that is consistent with safe obstruction clearance practices;

(5) Not obscure any light of the approach landing system; and

(6) Be installed on frangible mounts or beyond the 1000' light bar.

(b) On runways where limited terrain prevents the localizer antennae from being positioned on the runway centerline extended, and the cost of the land fill or a tall tower antenna support is prohibitive, the localizer antenna array may be offset, including a collocated ground station, so that the course intercepts the centerline at a point determined by the amount of the angular offset and the glide path angle. If other than a runway centerline localizer is used, the criteria in subpart C of part 97 of this chapter is applicable.

(c) At locations where two separate ISMLS facilities serve opposite ends of a single runway, an interlock must ensure that only the facility serving the approach direction being used will radiate.

(d) The radiation from the localizer antenna system must produce a composite field pattern which is pulse duration modulated, the time average equivalent to amplitude modulation by a 90 Hz and 150 Hz tone. The localizer station must transmit angular guidance information over a C-band microwave carrier on narrow, scanned antenna beams that are encoded to produce a modulation in space which, after averaging over several beam scans, is equivalent to the modulation used for conventional ILS as specified in subpart C of this part. The radiation field pattern must produce a course sector with one tone predominating on one side of the course and with the other tone predominating on the opposite side. When an observer faces the localizer from the approach end of the runway, the depth of modulation of the radio frequency carrier due to the 150 Hz tone must predominate on his right hand and that due to the 90 Hz tone must predominate on his left hand.

(e) All horizontal angles employed in specifying the localizer field patterns must originate from the center of the localizer antenna system which provides the signals used in the front course sector.

(f) The ISMLS course sector angle must be adjustable between 3 degrees and 9 degrees. The applicable course sector angle will be established and approved on an individual basis.

(g) The ISMLS localizer must operate in the band 5000 MHz to 5030 MHz. The frequency tolerance may not exceed ± 0.0001 percent.

(h) The emission from the localizer must be vertically polarized. The horizontally polarized component of the radiation of the course line may not exceed that which corresponds to a DDM error of 0.016 when an aircraft is positioned on the course line and is in a roll attitude of 20 degrees from the horizontal.

(i) The localizer must provide signals sufficient to allow satisfactory operation of a typical aircraft installation

within the localizer and glide path coverage sectors. The localizer coverage sector must extend from the center of the localizer antenna system to distances of 18 nautical miles minimum within ± 10 degrees from the front course line, and 10 nautical miles minimum between ± 10 degrees and ± 35 degrees from the front course line. The ISMLS localizer signals must be receivable at the distances specified up from a surface extending outward from the localizer antenna and within a sector in the elevation plane from 0.300 to 1.750 of the established glide path angle (θ).

(j) Except as provided in paragraph (k) of this section, in all parts of the coverage volume specified in paragraph (i) of this section, the peak field strength may not be less than -87 dBW/m², and must permit satisfactory operational usage of ISMLS localizer facilities.

(k) The minimum peak field strength on the ISMLS glide path and within the localizer course sector from a distance of 10 nautical miles to a height of 100 feet (30 meters) above the horizontal plane containing the threshold, may not be less than $+87$ dBW/m².

(l) Above 16 degrees, the ISMLS localizer signals must be reduced to as low a value as practicable.

(m) Bends in the course line may not have amplitudes which exceed the following:

Zone	Amplitude (DDM) (95 pct. probability)
Outer limit of coverage to: ISMLS point "A"	0.031.
ISMLS point "A" to ISMLS point "B".	0.031 at ISMLS point "A" decreasing at linear rate to 0.015 at ISMLS point "B".
ISMLS point "B" to ISMLS point "C".	0.015.

(n) The amplitudes referred to in paragraph (m) of this section are the DDMs due to bends as realized on the mean course line, when correctly adjusted.

(o) The radio frequency carrier must meet the following requirements:

(1) The nominal depth of modulation of the radio frequency carrier due to each of the 90 Hz and 150 Hz tones must be 20 percent along the course line.

(2) The depth of modulation of the radio frequency carrier due to each of

the 90 Hz and 150 Hz tones must be between 18 and 22 percent.

(3) The frequency tolerance of the 90 Hz and 150 Hz modulated tones must be within ± 25 percent.

(4) Total harmonic content of the 90 Hz tone may not exceed 10 percent.

(5) Total harmonic content of the 150 Hz tone may not exceed 10 percent. However, a 300 Hz tone may be transmitted for identification purposes.

(6) At every half cycle of the combined 90 Hz and 150 Hz wave form, the modulation tones must be phase-locked so that within the half course sector, the demodulated 90 Hz and 150 Hz wave forms pass through zero in the same direction within 20 degrees with phase relative to the 150 Hz component. However, the phase need not be measured within the half course sector.

(p) The mean course line must be adjusted and maintained within ± 0.15 DDM from the runway centerline at the ISMLS reference datum.

(q) The nominal displacement sensitivity within the half course sector at the ISMLS reference datum, must be 0.00145 DDM/meter (0.00044DDM/foot). However, where the specified nominal displacement sensitivity cannot be met, the displacement sensitivity must be adjusted as near as possible to that value.

(r) The lateral displacement sensitivity must be adjusted and maintained within 17 percent of the nominal value. Nominal sector width at the ISMLS reference datum is 210 meters (700 feet).

(s) The increase of DDM must be substantially linear with respect to angular displacement from the front course line where DDM is zero, up to angle on either side of the front course line where the DDM is 0.180. From that angle to ± 10 degrees, the DDM may not be less than 0.180. From ± 10 degrees to ± 35 degrees, the DDM may not be less than 0.155.

(t) The localizer must provide for the simultaneous transmission of an identification signal which meets the following:

(1) It must be specific to the runway and approach direction, on the same radio frequency carrier, as used for the localizer function.

§ 171.263

(2) Transmission of the identification signal may not interfere in any way with the basic localizer function.

(3) The signal must be produced by pulse duration modulation of the radio frequency carrier resulting in a detected audio tone in the airborne VHF receiver of 1020 Hz \pm 50Hz.

(4) The depth of modulation must be between the limits of 10 and 12 percent.

(5) The emissions carrying the identification signal must be vertically polarized.

(6) The identification signal must employ the International Morse Code and consist of three letters. It must be preceded by the International Morse Code signal of the letter "M" followed by a short pause where it is necessary to distinguish the ISMLS facility from other navigational facilities in the immediate area. At airports where both an ISMLS and an ILS are in operation, each facility must have a different identification call sign.

(7) The signal must be transmitted at a speed corresponding to approximately seven words per minute, and must be repeated at approximately equal intervals, not less than six times per minute, during which time the localizer is available for operational use. When the localizer is not available for transmission, the identification signal must be suppressed.

§ 171.263 Localizer automatic monitor system.

(a) The ISMLS localizer equipment must provide an automatic monitor system that transmits a warning to designated local and remote control points when any of the following occurs:

(1) A shift of the mean course line of the localizer from the runway centerline equivalent to more than 0.015 DDM at the ISMLS reference datum.

(2) For localizers in which the basic functions are provided by the use of a single-frequency system, a reduction of power output to less than 50 percent of normal or a loss of ground station identification transmissions.

(3) Changes of displacement sensitivity to a value differing by more than 17 percent from nominal value for the localizer.

14 CFR Ch. I (1-1-24 Edition)

(4) Failure of any part of the monitor itself. Such failure must automatically produce the same results as the malfunctioning of the element being monitored.

(b) Within 10 seconds of the occurrence of any of the conditions prescribed in paragraph (a) of this section, including periods of zero radiation, localizer signal radiation must cease or the navigation and identification components must be removed.

§ 171.265 Glide path performance requirements.

This section prescribes the performance requirements for glide path equipment components of the ISMLS. These requirements are based on the assumption that the aircraft is heading directly toward the facility.

(a) The glide slope antenna system must be located near the approach end of the runway, and the equipment must be adjusted so that the vertical path line will be in a sloping horizontal plane containing the centerline of the runway being served, and satisfy the coverage requirements prescribed in paragraph (g) of this section. For the purpose of obstacle clearance, location of the glide slope antenna system must be in accordance with the criteria specified in subpart C of part 97 of this chapter.

(b) The radiation from the glide path antenna system must produce a composite field pattern which is pulse duration modulated by a 90 Hz and a 150 Hz tone, which is the time average equivalent to amplitude modulation. The pattern must be arranged to provide a straight line descent path in the vertical plane containing the centerline of the runway, with the 150 Hz tone predominating below the path and the 90 Hz tone predominating above the path to at least an angle equal to 1.752θ . As used in this section θ , denotes the nominal glide path angle. The glide path angle must be adjusted and maintained within 0.075 θ .

(c) The glide path equipment must be capable of producing a radiated glide path from 3 to 9 degrees with respect to the horizontal. However, ISMLS glide path angles in excess of 3 degrees may be used to satisfy instrument approach

procedures or to overcome an obstruction clearance problem, only in accordance with the criteria specified in subpart C of part 97 of this chapter.

(d) The downward extended straight portion of the ISMLS glide path must pass through the ISMLS reference datum at a height ensuring safe guidance over obstructions and safe and efficient use of the runway served. The height of the ISMLS reference datum must be in accordance with subpart C of part 97 of this chapter.

(e) The glide path equipment must operate in the band 5220 MHz to 5250 MHz. The frequency tolerance may not exceed ± 0.0001 percent.

(f) The emission from the glide path equipment must be vertically polarized.

(g) The glide path equipment must provide signals sufficient to allow satisfactory operation of a typical aircraft installation in sectors of 8 degrees on each side of the centerline of the ISMLS glide path, to a distance of at least 10 nautical miles up to 1.75 θ and down to 0.45 θ above the horizontal or to such lower angle at which 0.22 DDM is realized.

(h) To provide the coverage for glide path performance specified in paragraph (g) of this section, the minimum peak field strength within this coverage sector must be -82 dBW/m². The peak field strength must be provided on the glide path down to a height of 30 meters (100 feet) above the horizontal plane containing the threshold.

(i) Bends in the glide path may not have amplitudes which exceed the following:

Zone	Amplitude (DDM) (95 pct. probability)
Outer limit of coverage to ISMLS point "C."	0.035.

The amplitude referred to is the DDM due to bends as realized on the mean ISMLS glide path correctly adjusted. In regions of the approach where ISMLS glide path curvature is significant, bend amplitude is calculated from the mean curved path, and not the downward extended straight line.

(j) Guidance modulation must be impressed on the microwave carrier of the radiated glide slope signal in the form

of a unique summation of 90 Hz and 150 Hz sinusoidal modulation corresponding to the point direction of the particular beam which radiates the signal. Each of the effective beam positions must be illuminated in sequence for a short time interval. The scan rate must be synchronous with the 90 and 150 Hz tone base. The modulation impressed on each beam must be a sample of the combined 90 Hz and 150 Hz waveform appropriate for that particular beam direction and time slot. The actual modulation must be accomplished by appropriately varying the length of time the carrier is radiated during each beam illumination interval.

(k) The nominal depth of modulation of the radio frequency carrier due to each of the 90 Hz and 150 Hz tones must be 40 percent along the ISMLS glide path. The depth of modulation may not deviate outside the limits of 37.5 percent to 42.5 percent.

(l) The following tolerances apply to the frequencies of the modulating tones:

(1) The modulating tones must be 90 Hz and 150 Hz within 2.5 percent.

(2) The total harmonic content of the 90 Hz tone may not exceed 10 percent.

(3) The total harmonic content of the 150 Hz tone may not exceed 10 percent.

(m) At every half cycle of the combined 90 Hz and 150 Hz wave form, the modulation must be phase-locked so that, within the ISMLS half glide path sector, the demodulated 90 Hz and 150 Hz wave forms pass through zero in the same direction within 20 degrees of phase relative to the 150 Hz component. However, the phase need not be measured within the ISMLS half glide path sector.

(n) The nominal angular displacement sensitivity must correspond to a DDM of 0.0875 at an angular displacement above and below the glide path of 0.12 θ . The glide path angular displacement sensitivity must be adjusted and maintained within ± 25 percent of the nominal value selected. The upper and lower sectors must be as symmetrical as practicable within the limits prescribed in this paragraph.

(o) The DDM below the ISMLS glide path must increase smoothly for decreasing angle until a value of 0.22 DDM is reached. This value must be

§ 171.267

achieved at an angle not less than 0.300 above the horizontal. However, if it is achieved at an angle above 0.450, the DDM value may not be less than 0.22 at least down to an angle of 0.450.

[Doc. No. 14120, 40 FR 36110, Aug. 19, 1975; 40 FR 41093, Sept. 5, 1975; 40 FR 43719, Sept. 23, 1975]

§ 171.267 Glide path automatic monitor system.

(a) The ISMLS glide path equipment must provide an automatic monitor system that transmits a warning to designated local and remote control points when any of the following occurs:

(1) A shift of the mean ISMLS glide path angle equivalent to more than 0.0750.

(2) For glide paths in which the basic functions are provided by the use of a single frequency system, a reduction of power output to less than 50 percent.

(3) A change of the angle between the glide path and the line below the glide path (150 Hz predominating), at which a DDM of 0.0875 is realized by more than ± 0.03750 .

(4) Lowering of the line beneath the ISMLS glide path at which a DDM of 0.0875 is realized to less than 0.750 from the horizontal.

(5) Failure of any part of the monitor itself. Such failure must automatically produce the same results as the malfunctioning of the element being monitored.

(b) At glide path facilities where the selected nominal angular displacement sensitivity corresponds to an angle below the ISMLS glide path, which is close to or at the maximum limits specified, an adjustment to the monitor operating limits may be made to protect against sector deviations below 0.750 from the horizontal.

(c) Within 10 seconds of the occurrence of any of the conditions prescribed in paragraph (a) of this section, including periods of zero radiation, glide path signal radiation must cease.

§ 171.269 Marker beacon performance requirements.

ISMLS marker beacon equipment must meet the performance requirements prescribed in subpart H of this part.

14 CFR Ch. I (1–1–24 Edition)

§ 171.271 Installation requirements.

(a) The ISMLS facility must be permanent in nature, located, constructed, and installed according to accepted good engineering practices, applicable electric and safety codes, FCC licensing requirements, and paragraphs (a) and (c) of § 171.261.

(b) The ISMLS facility must have a reliable source of suitable primary power, either from a power distribution system or locally generated. Adequate power capacity must be provided for the operation of test and working equipment of the ISMLS.

(c) The ISMLS facility must have a continuously engaged or floating battery power source for the ground station for continued normal operation if the primary power fails. A trickle charge must be supplied to recharge the batteries during the period of available primary power. Upon loss and subsequent restoration of power, the batteries must be restored to full charge within 24 hours. When primary power is applied, the state of the battery charge may not affect the operation of the ISMLS ground station. The battery must permit continuation of normal operation for at least two hours under the normal operating conditions. The equipment must meet all specification requirements with or without batteries installed.

(d) There must be a means for determining, from the ground, the performance of the equipment including antennae, both initially and periodically.

(e) The facility must have, or be supplemented by, ground-air or landline communications services. At facilities within or immediately adjacent to controlled airspace and that are intended for use as instrument approach aids for an airport, there must be ground-air communications or reliable communications (at least a landline telephone) from the airport to the nearest Federal Aviation Administration air traffic control or communication facility. Compliance with this paragraph need not be shown at airports where an adjacent Federal Aviation Administration facility can communicate with aircraft on the ground at the airport and during the entire proposed instrument approach procedure. In addition, at low traffic density airports within

or immediately adjacent to controlled airspace, and where extensive delays are not a factor, the requirements of this paragraph may be reduced to reliable communications (at least a landline telephone) from the airport to the nearest Federal Aviation Administration air traffic control or communications facility, if an adjacent Federal Aviation Administration facility can communicate with aircraft during the proposed instrument approach procedure, at least down to the minimum en route altitude for the controlled area.

(f) Except where no operationally harmful interference will result, at locations where two separate ISMLS facilities serve opposite ends of a single runway, an interlock must ensure that only the facility serving the approach direction in use can radiate.

[Doc. No. 14120, 40 FR 36110, Aug. 19, 1975, as amended by Amdt. 171-16, 56 FR 65665, Dec. 17, 1991]

§ 171.273 Maintenance and operations requirements.

(a) The owner of the facility must establish an adequate maintenance system and provide qualified maintenance personnel to maintain the facility at the level attained at the time it was commissioned. Each person who maintains a facility must meet at least the Federal Communications Commission's licensing requirements and show that he has the special knowledge and skills needed to maintain the facility, including proficiency in maintenance procedures and the use of specialized test equipment.

(b) In the event of out-of-tolerance conditions or malfunctions, as evidenced by receiving two successive pilot reports, the owner must close the facility by ceasing radiation, and issue a "Notice to Airman" (NOTAM) that the facility is out of service.

(c) The owner must prepare, and obtain approval of, an operations and maintenance manual that sets forth mandatory procedures for operations, periodic maintenance, and emergency maintenance, including instructions on each of the following:

- (1) Physical security of the facility.
- (2) Maintenance and operations by authorized persons.

(3) FCC licensing requirements for operations and maintenance personnel.

(4) Posting of licenses and signs.

(5) Relation between the facility and FAA air traffic control facilities, with a description of the boundaries of controlled airspace over or near the facility, instructions for relaying air traffic control instructions and information, if applicable, and instructions for the operation of an air traffic advisory service if the facility is located outside of controlled airspace.

(6) Notice to the Administrator of any suspension of service.

(7) Detailed and specific maintenance procedures and servicing guides stating the frequency of servicing.

(8) Air-ground communications, if provided, expressly written or incorporating appropriate sections of FAA manuals by reference.

(9) Keeping of station logs and other technical reports, and the submission of reports required by § 171.275.

(10) Monitoring of the ISMLS facility.

(11) Inspections by United States personnel.

(12) Names, addresses, and telephone numbers of persons to be notified in an emergency.

(13) Shutdowns for periodic maintenance and issue of "Notices to Airmen" for routine or emergency shutdowns.

(14) Commissioning of the ISMLS facility.

(15) An acceptable procedure for amending or revising the manual.

(16) An explanation of the kinds of activities (such as construction or grading) in the vicinity of the ISMLS facility that may require shutdown or recertification of the ISMLS facility by FAA flight check.

(17) Procedures for conducting a ground check of the localizer course alignment, width, and clearance, glide path elevation angle and course width, and marker beacon power, and modulation.

(18) The following information concerning the ISMLS facility:

(i) Facility component locations with respect to airport layout, instrument runways, and similar areas.

(ii) The type, make, and model of the basic radio equipment that provides the service.

(iii) The station power emission and frequencies of the ISMLS localizer, glide path, beacon markers, and associated compass locators, if any.

(iv) The hours of operation.

(v) Station identification call letters and method of station identification and the time spacing of the identification.

(vi) A description of the critical parts that may not be changed, adjusted, or repaired without an FAA flight check to confirm published operations.

(d) The owner or his maintenance representative must make a ground check of the ISMLS facility periodically in accordance with procedures approved by the FAA at the time of commissioning, and must report the results of the checks as provided in § 171.275.

(e) Modifications to an ISMLS facility may be made only after approval by the FAA of the proposed modification submitted by the owner.

(f) The owner or the owner's maintenance representative must participate in inspections made by the FAA.

(g) Whenever it is required by the FAA, the owner must incorporate improvements in ISMLS maintenance.

(h) The owner or his maintenance representative must provide a sufficient stock of spare parts, including solid state components, or modules to make possible the prompt replacement of components or modules that fail or deteriorate in service.

(i) FAA approved test instruments must be used for maintenance of the ISMLS facility.

(j) The mean corrective maintenance time of the ISMLS equipment may not exceed 0.5 hours, with a maximum corrective maintenance time of not greater than 1.5 hours. This measure applies to failures of the monitor, transmitter and associated antenna assemblies, limited to unscheduled outage and out-of-tolerance conditions.

(k) The mean time between failures of the ISMLS equipment may not be less than 1,500 hours. This measure applies to unscheduled outages, out-of-tolerance conditions, and failures of the monitor, transmitter, and associated antenna assemblies.

(l) Inspection consists of an examination of the ISMLS equipment to ensure

that unsafe operating conditions do not exist.

(m) Monitoring of the ISMLS radiated signal must ensure a high degree of integrity and minimize the requirements for ground and flight inspection. The monitor must be checked periodically during the in-service test evaluation period for calibration and stability. These tests and ground checks of glide slope, localizer, and marker beacon radiation characteristics must be conducted in accordance with the maintenance requirements of this section.

§ 171.275 Reports.

The owner of the ISMLS facility or his maintenance representative must make the following reports at the indicated time to the appropriate FAA Regional Office where the facility is located.

(a) *Facility Equipment Performance and Adjustment Data (FAA Form 198)*. The FAA Form 198 shall be filled out by the owner or his maintenance representative with the equipment adjustments and meter readings as of the time of facility commissioning. One copy must be kept in the permanent records of the facility and two copies must be sent to the appropriate FAA Regional Office. The owner or his maintenance representative must revise the FAA Form 198 data after any major repair, modernization, or retuning to reflect an accurate record of facility operation and adjustment. In the event the data are revised, the owner or his maintenance representative shall notify the appropriate FAA Regional Office of such revisions, and forward copies of the revisions to the appropriate FAA Regional Office.

(b) *Facility Maintenance Log (FAA Form 6030-1)*. FAA Form 6030-1 is a permanent record of all the activities required to maintain the ISMLS facility. The entries must include all malfunctions met in maintaining the facility including information on the kind of work and adjustments made, equipment failures, causes (if determined) and corrective action taken. In addition, the entries must include completion of periodic maintenance required to maintain the facility. The owner or his maintenance representative must

keep the original of each form at the facility and send a copy to the appropriate FAA Regional Office at the end of each month in which it is prepared. However, where an FAA approved remote monitoring system is installed which precludes the need for periodic maintenance visits to the facility, monthly reports from the remote monitoring system control point must be forwarded to the appropriate FAA Regional Office, and a hard copy retained at the control point.

(c) *Technical Performance Record (FAA Form 418)*. FAA Form 418 contains a record of system parameters, recorded on each scheduled visit to the facility. The owner or his maintenance representative shall keep the original of each month's record at the facility and send a copy of the form to the appropriate FAA Regional Office.

Subpart J—Microwave Landing System (MLS)

SOURCE: Docket No. 20669, 51 FR 33177, Sept. 18, 1986, unless otherwise noted.

§ 171.301 Scope.

This subpart sets forth minimum requirements for the approval, installation, operation and maintenance of non-Federal Microwave Landing System (MLS) facilities that provide the basis for instrument flight rules (IFR) and air traffic control procedures.

§ 171.303 Definitions.

As used in this subpart:

Auxiliary data means data transmitted in addition to basic data that provide ground equipment siting information for use in refining airborne position calculations and other supplementary information.

Basic data means data transmitted by the ground equipment that are associated directly with the operation of the landing guidance system.

Beam center means the midpoint between the -3 dB points on the leading and trailing edges of the scanning beam main lobe.

Beamwidth means the width of the scanning beam main lobe measured at the -3 dB points and defined in angular units on the boresight, in the horizontal plane for the azimuth function

and in the vertical plane for the elevation function.

Clearance guidance sector means the volume of airspace, inside the coverage sector, within which the azimuth guidance information provided is not proportional to the angular displacement of the aircraft, but is a constant fly-left or fly-right indication of the direction relative to the approach course the aircraft should proceed in order to enter the proportional guidance sector.

Control Motion Noise (CMN) means those fluctuations in the guidance which affect aircraft attitude, control surface motion, column motion, and wheel motion. Control motion noise is evaluated by filtering the flight error record with a band-pass filter which has corner frequencies at 0.3 radian/sec and 10 radians/sec for azimuth data and 0.5 radian/sec and 10 radians/sec for elevation data.

Data rate means the average number of times per second that transmissions occur for a given function.

Differential Phase Shift Keying (DPSK) means differential phase modulation of the radio frequency carrier with relative phase states of 0 degree or 180 degrees.

Failure means the inability of an item to perform within previously specified limits.

Guard time means an unused period of time provided in the transmitted signal format to allow for equipment tolerances.

Integrity means that quality which relates to the trust which can be placed in the correctness of the information supplied by the facility.

Mean corrective time means the average time required to correct an equipment failure over a given period, after a service technician reaches the facility.

Mean course error means the mean value of the azimuth error along a specified radial of the azimuth function.

Mean glide path error means the mean value of the elevation error along a specified glidepath of the elevation function.

Mean-time-between-failures (MTBF) means the average time between equipment failures over a given period.

§ 171.305

Microwave Landing System (MLS) means the MLS selected by ICAO for international standardization.

Minimum glidepath means the lowest angle of descent along the zero degree azimuth that is consistent with published approach procedures and obstacle clearance criteria.

MLS Approach Reference Datum is a point at a specified height located vertically above the intersection of the runway centerline and the threshold.

MLS back azimuth reference datum means a point 15 meters (50 feet) above the runway centerline at the runway midpoint.

MLS datum point means a point defined by the intersection of the runway centerline with a vertical plane perpendicular to the centerline and passing through the elevation antenna phase center.

Out of coverage indication (OCI) means a signal radiated into areas outside the intended coverage sector, where required, to specifically prevent invalid removal of an airborne warning indication in the presence of misleading guidance information.

Path Following Error (PFE) means the guidance perturbations which could cause aircraft displacement from the desired course or glidepath. It is composed of the path following noise and of the mean course error in the case of azimuth functions, or the mean glidepath error in the case of elevation functions. Path following errors are evaluated by filtering the flight error record with a second order low pass filter which has a corner frequency at 0.5 radian/sec for azimuth data or 1.5 radians/sec for elevation data.

Path following noise (PFN) means that portion of the guidance signal error which could cause displacement from the actual mean course line or mean glidepath as appropriate.

Split-site ground station means the type of ground station in which the azimuth portion of the ground station is located near the stop end of the runway, and the elevation portion is located near the approach end.

Time division multiplex (TDM) means that each function is transmitted on the same frequency in time sequence, with a distinct preamble preceding each function transmission.

14 CFR Ch. I (1–1–24 Edition)

§ 171.305 Requests for IFR procedure.

(a) Each person who requests an IFR procedure based on an MLS facility which that person owns must submit the following information with that request:

(1) A description of the facility and evidence that the equipment meets the performance requirements of §§ 171.309, 171.311, 171.313, 171.315, 171.317, 171.319, and 171.321 and is fabricated and installed in accordance with § 171.323.

(2) A proposed procedure for operating the facility.

(3) A proposed maintenance organization and a maintenance manual that meets the requirements of § 171.325.

(4) A statement of intent to meet the requirements of this subpart.

(5) A showing that the facility has an acceptable level of operational reliability and an acceptable standard of performance. Previous equivalent operational experience with a facility with identical design and operational characteristics will be considered in showing compliance with this subparagraph.

(b) FAA inspects and evaluates the MLS facility; it advises the owner of the results, and of any required changes in the MLS facility or in the maintenance manual or maintenance organization. The owner must then correct the deficiencies, if any, and operate the MLS facility for an in-service evaluation by the FAA.

§ 171.307 Minimum requirements for approval.

(a) The following are the minimum requirements that must be met before the FAA approves an IFR procedure for a non-Federal MLS facility:

(1) The performance of the MLS facility, as determined by flight and ground inspection conducted by the FAA, must meet the requirements of §§ 171.309, 171.311, 171.313, 171.315, 171.317, 171.319, and 171.321.

(2) The fabrication and installation of the equipment must meet the requirements of § 171.323.

(3) The owner must agree to operate and maintain the MLS facility in accordance with § 171.325.

(4) The owner must agree to furnish operational records as set forth in § 171.327 and agree to allow the FAA to

inspect the facility and its operation whenever necessary.

(5) The owner must assure the FAA that he will not withdraw the MLS facility from service without the permission of the FAA.

(6) The owner must bear all costs of meeting the requirements of this section and of any flight or ground inspection made before the MLS facility is commissioned.

(b) [Reserved]

§ 171.309 General requirements.

The MLS is a precision approach and landing guidance system which provides position information and various ground-to-air data. The position information is provided in a wide coverage sector and is determined by an azimuth angle measurement, an elevation angle measurement and a range (distance) measurement.

(a) An MLS constructed to meet the requirements of this subpart must include:

(1) Approach azimuth equipment, associated monitor, remote control and indicator equipment.

(2) Approach elevation equipment, associated monitor, remote control and indicator equipment.

(3) A means for the encoding and transmission of essential data words, associated monitor, remote control and indicator equipment. Essential data are basic data words 1, 2, 3, 4, and 6 and auxiliary data words A1, A2 and A3.

(4) Distance measuring equipment (DME), associated monitor, remote control and indicator equipment.

(5) Remote controls for paragraphs (a) (1), (2), (3), and (4) of this section must include as a minimum on/off and reset capabilities and may be integrated in the same equipment.

(6) At locations where a VHF marker beacon (75 MHz) is already installed, it may be used in lieu of the DME equipment.

(b) In addition to the equipment required in paragraph (a) of this section the MLS may include:

(1) Back azimuth equipment, associated monitor, remote control and indicator equipment. When Back Azimuth is provided, a means for transmission of Basic Data Word 5 and Auxiliary Data Word A4 shall also be provided.

(2) A wider proportional guidance sector which exceeds the minimum specified in §§ 171.313 and 171.317.

(3) Precision DME, associated monitor, remote control and indicator equipment.

(4) VHF marker beacon (75 MHz), associated monitor, remote control and indicator equipment.

(5) The MLS signal format will accommodate additional functions (e.g., flare elevation) which may be included as desired. Remote controls for paragraphs (b) (1), (3) and (4) of this section must include as a minimum on/off and reset capabilities, and may be integrated in the same equipment.

(6) Provisions for the encoding and transmission of additional auxiliary data words, associated monitor, remote control and indicator equipment.

(c) MLS ground equipment must be designed to operate on a nominal 120/240 volt, 60 Hz, 3-wire single phase AC power source and must meet the following service conditions:

(1) AC line parameters, DC voltage, elevation and duty:

120 VAC nominal value—102 V to 138 V (± 1 V)*

240 VAC nominal value—204 V to 276 V (± 2 V)*

60 Hz AC line frequency—57 Hz to 63 Hz (± 0.2 Hz)*

*NOTE: Where discrete values of the above frequency or voltages are specified for testing purposes, the tolerances given in parentheses indicated by an asterisk apply to the test instruments used to measure these parameters.

Elevation—0 to 3000 meters (10,000 feet) above sea level

Duty—Continuous, unattended

(2) Ambient conditions within the shelter for electronic equipment installed in shelters are:

Temperature, -10°C to $+50^{\circ}\text{C}$

Relative humidity, 5% to 90%

(3) Ambient conditions for electronic equipment and all other equipment installed outdoors (for example, antenna, field detectors, and shelters):

Temperature, -50°C to $+70^{\circ}\text{C}$

Relative humidity, 5% to 100%

(4) All equipment installed outdoors must operate satisfactorily under the following conditions:

§ 171.311

14 CFR Ch. I (1–1–24 Edition)

Wind Velocity: The ground equipment shall remain within monitor limits with wind velocities of up to 70 knots from such directions that the velocity component perpendicular to runway centerline does not exceed 35 knots. The ground equipment shall withstand winds up to 100 knots from any direction without damage.

Hail Stones: 1.25 centimeters (½ inch) diameter.

Rain: Provide required coverage with rain falling at a rate of 50 millimeters (2 inches) per hour, through a distance of 9 kilometers (5 nautical miles) and with rain falling at the rate of 25 millimeters (1 inch) per hour for the additional 28 kilometers (15 nautical miles).

Ice Loading: Encased in 1.25 centimeters (½ inch) radial thickness of clear ice.

Antenna Radome De-Icing: Down to –6 °C (20 °F) and wind up to 35 knots.

(d) The transmitter frequencies of an MLS must be in accordance with the frequency plan approved by the FAA.

(e) The DME component listed in paragraph (a)(4) of this section must comply with the minimum standard performance requirements specified in subpart G of this part.

(f) The marker beacon components listed in paragraph (b)(4) of this section must comply with the minimum standard performance requirements specified in subpart H of this part.

§ 171.311 Signal format requirements.

The signals radiated by the MLS must conform to the signal format in which angle guidance functions and data functions are transmitted sequentially on the same C-band frequency. Each function is identified by a unique digital code which initializes the airborne receiver for proper processing.

The signal format must meet the following minimum requirements:

(a) *Frequency assignment.* The ground components (except DME/Marker Beacon) must operate on a single frequency assignment or channel, using time division multiplexing. These components must be capable of operating on any one of the 200 channels spaced 300 KHz apart with center frequencies from 5031.0 MHz to 5090.7 MHz and with channel numbering as shown in Table 1a. The operating radio frequencies of all ground components must not vary by more than ±10 KHz from the assigned frequency. Any one transmitter frequency must not vary more than ±50 Hz in any one second period. The MLS angle/data and DME equipment must operate on one of the paired channels as shown in Table 1b.

TABLE 1a—FREQUENCY CHANNEL PLAN

Channel No.	Frequency (MHz)
500	5031.0
501	5031.3
502	5031.6
503	5031.9
504	5032.2
505	5032.5
506	5032.8
507	5033.1
508	5033.4
509	5033.7
510	5034.0
511	5034.3
* * * * *	
598	5060.4
599	5060.7
600	5061.0
601	5061.3
* * * * *	
698	5090.4
699	5090.7

TABLE 1b—CHANNELS

Channel pairing				DME parameters					
DME No.	VHF freq. MHz	MLS angle freq. MHz	MLS Ch. No.	Interrogation			Reply		
				Freq. MHz	Pulse codes		Freq. MHz	Pulse codes μs	
					DME/N μs	DME/P Mode			
				IA μs	FA μs				
* 1X				1025	12			962	12
** 1Y				1025	36			1088	30
* 2X				1026	12			963	12
** 2Y				1026	36			1089	30
* 3X				1027	12			964	12
** 3Y				1027	36			1090	30
* 4X				1028	12			965	12
** 4Y				1028	36			1091	30
* 5X				1029	12			966	12

TABLE 1b—CHANNELS—Continued

Channel pairing				DME parameters					
DME No.	VHF freq. MHz	MLS angle freq. MHz	MLS Ch. No.	Interrogation			Reply		
				Freq. MHz	Pulse codes		Freq. MHz	Pulse codes μ s	
					DME/N μ s	DME/P Mode			
		IA μ s	FA μ s						
**5Y				1029	36			1092	30
*6X				1030	12			967	12
**6Y				1030	36			1093	30
*7X				1031	12			968	12
**7Y				1031	36			1094	30
*8X				1032	12			969	12
**8Y				1032	36			1095	30
*9X				1033	12			970	12
**9Y				1033	36			1096	30
*10X				1034	12			971	12
**10Y				1034	36			1097	30
*11X				1035	12			972	12
**11Y				1035	36			1098	30
*12X				1036	12			973	12
**12Y				1036	36			1099	30
*13X				1037	12			974	12
**13Y				1037	36			1100	30
*14X				1038	12			975	12
**14Y				1038	36			1101	30
*15X				1039	12			976	12
**15Y				1039	36			1102	30
*16X				1040	12			977	12
**16Y				1040	36			1103	30
∇17X	108.00			1041	12			978	12
17Y	108.05	5043.0	540	1041	36	36	42	1104	30
17Z		5043.3	541	1041		21	27	1104	15
18X	108.10	5031.0	500	1042	12	12	18	979	12
18W		5031.3	501	1042		24	30	979	24
18Y	108.15	5043.6	542	1042	36	36	42	1105	30
18Z		5043.9	543	1042		21	27	1105	15
19X	108.20			1043	12			980	12
19Y	108.25	5044.2	544	1043	36	36	42	1106	30
19Z		5044.5	545	1043		21	27	1106	15
20X	108.30	5031.6	502	1044	12	12	18	981	12
20W		5031.9	503	1044		24	30	981	24
20Y	108.35	5044.8	546	1044	36	36	42	1107	30
20Z		5045.1	547	1044		21	27	1107	15
21X	108.40			1045	12			982	12
21Y	108.45	5045.4	548	1045	36	36	42	1108	30
21Z		5045.7	549	1045		21	27	1108	15
22X	108.50	5032.2	504	1046	12	12	18	983	12
22W		5032.5	505	1046		24	30	983	24
22Y	108.55	5046.0	550	1046	36	36	42	1109	30
22Z		5046.3	551	1046		21	27	1109	15
23X	108.60			1047	12			984	12
23Y	108.65	5046.6	552	1047	36	36	42	1110	30
23Z		5046.9	553	1047		21	27	1110	15
24X	108.70	5032.8	506	1048	12	12	18	985	12
24W		5033.1	507	1048		24	30	985	24
24Y	108.75	5047.2	554	1048	36	36	42	1111	30
24Z		5047.5	555	1048		21	27	1111	15
25X	108.80			1049	12			986	12
25Y	108.85	5047.8	556	1049	36	36	42	1112	30
25Z		5048.1	557	1049		21	27	1112	15
26X	108.90	5033.4	508	1050	12	12	18	987	12
26W		5033.7	509	1050		24	30	987	24
26Y	108.95	5048.4	558	1050	36	36	42	1113	30
26Z		5048.7	559	1050		21	27	1113	15
27X	109.00			1051	12			988	12
27Y	109.05	5049.0	560	1051	36	36	42	1114	30
27Z		5049.3	561	1051		21	27	1114	15
28X	109.10	5034.0	510	1052	12	12	18	989	12
28W		5034.3	511	1052		24	30	989	24
28Y	109.15	5049.6	562	1052	36	36	42	1115	30
28Z		5049.9	563	1052		21	27	1115	15

TABLE 1b—CHANNELS—Continued

Channel pairing				DME parameters					
DME No.	VHF freq. MHz	MLS angle freq. MHz	MLS Ch. No.	Interrogation			Reply		
				Freq. MHz	Pulse codes		Freq. MHz	Pulse codes μ s	
					DME/N μ s	DME/P Mode			
IA μ s	FA μ s								
29X	109.20			1053	12			990	12
29Y	109.25	5050.2	564	1053	36	36	42	1116	30
29Z		5050.5	565	1043		21	27	1116	15
30X	109.30	5034.6	512	1054	12	12	18	991	12
30W		5034.9	513	1054		24	30	991	24
30Y	109.35	5050.8	566	1054	36	36	42	1117	30
30Z		5051.1	567	1054		21	27	1117	15
31X	109.40			1055	12			992	12
31Y	109.45	5051.4	568	1055	36	36	42	1118	30
31Z		5051.7	569	1055		21	27	1118	15
32X	109.50	5035.2	514	1056	12	12	18	993	12
32W		5035.5	515	1056		24	30	993	24
32Y	109.55	5052.0	570	1056	36	36	42	1119	30
32Z		5052.3	571	1056		21	27	1119	15
33X	109.60			1057	12			994	12
33Y	109.65	5052.6	572	1057	36	36	42	1120	30
33Z		5052.9	573	1057		21	27	1120	15
34X	109.70	5035.8	516	1058	12	12	18	995	12
34W		5036.1	517	1058		24	30	995	24
34Y	109.75	5053.2	574	1058	36	36	42	1121	30
34Z		5053.5	575	1058		21	27	1121	15
35X	109.80			1059	12			996	12
35Y	109.85	5053.8	576	1059	36	36	42	1122	30
35Z		5054.1	577	1059		21	27	1122	15
36X	109.90	5036.4	518	1060	12	12	18	997	12
36W		5036.7	519	1060		24	30	997	24
36Y	109.95	5054.4	578	1060	36	36	42	1123	30
36Z		5054.7	579	1060		21	27	1123	15
37X	110.00			1061	12			998	12
37Y	110.05	5055.0	580	1061	36	36	42	1124	30
37Z		5055.3	581	1061		21	27	1124	15
38X	110.10	5037.0	520	1062	12	12	18	999	12
38W		5037.3	521	1062		24	30	999	24
38Y	110.15	5055.6	582	1062	36	36	42	1125	30
38Z		5055.9	583	1062		21	27	1125	15
39X	110.20			1063	12			1000	12
39Y	110.25	5056.2	584	1063	36	36	42	1126	30
39Z		5056.5	585	1063		21	27	1126	15
40X	110.30	5037.6	522	1064	12	12	18	1001	12
40W		5037.9	523	1064		24	30	1001	24
40Y	110.35	5056.8	586	1064	36	36	42	1127	30
40Z		5057.1	587	1064		21	27	1127	15
41X	110.40			1065	12			1002	12
41Y	110.45	5057.4	588	1065	36	36	42	1128	30
41Z		5057.7	589	1065		21	27	1128	15
42X	110.50	5038.2	524	1066	12	12	18	1003	12
42W		5038.5	525	1066		24	30	1003	24
42Y	110.55	5058.0	590	1066	36	36	42	1129	30
42Z		5058.3	591	1066		21	27	1129	15
43X	110.60			1067	12			1004	12
43Y	110.65	5058.6	592	1067	36	36	42	1130	30
43Z		5058.9	593	1067		21	27	1130	15
44X	110.70	5038.8	526	1068	12	12	18	1005	12
44W		5039.1	527	1068		24	30	1005	24
44Y	110.75	5059.2	594	1068	36	36	42	1131	30
44Z		5059.5	595	1068		21	27	1131	15
45X	110.80			1069	12			1006	12
45Y	110.85	5059.8	596	1069	36	36	42	1132	30
45Z		5060.1	597	1069		21	27	1132	15
46X	110.90	5039.4	528	1070	12	12	18	1007	12
46W		5039.7	529	1070		24	30	1007	24
46Y	110.95	5060.4	598	1070	36	36	42	1133	30
46Z		5060.7	599	1070		21	27	1133	15
47X	111.00			1071	12			1008	12
47Y	111.05	5061.0	600	1071	36	36	42	1134	30

TABLE 1b—CHANNELS—Continued

Channel pairing				DME parameters					
DME No.	VHF freq. MHz	MLS angle freq. MHz	MLS Ch. No.	Interrogation			Reply		
				Freq. MHz	Pulse codes		Freq. MHz	Pulse codes μ s	
					DME/N μ s	DME/P Mode			
		IA μ s	FA μ s						
47Z		5061.3	601	1071	21	27	1134	15
48X	111.10	5040.0	530	1072	12	12	18	1009	12
48W		5040.3	531	1072	24	30	1009	24
48Y	111.15	5061.6	602	1072	36	36	42	1135	30
48Z		5061.9	603	1072	21	27	1135	15
49X	111.20	1073	12	1010	12
49Y	111.25	5062.2	604	1073	36	36	42	1136	30
49Z		5062.5	605	1073	21	27	1136	15
50X	111.30	5040.6	532	1074	12	12	18	1011	12
50W		5040.9	533	1074	24	30	1011	24
50Y	111.35	5062.8	606	1074	36	36	42	1137	30
50Z		5063.1	607	1074	21	27	1137	15
51X	111.40	1075	12	1012	12
51Y	111.45	5063.4	608	1075	36	36	42	1138	30
51Z		5063.7	609	1075	21	27	1138	15
52X	111.50	5041.2	534	1076	12	12	18	1013	12
52W		5041.5	535	1076	24	30	1013	24
52Y	111.55	5064.0	610	1076	36	36	42	1139	30
52Z		5064.3	611	1076	21	27	1139	15
53X	111.60	1077	12	1014	12
53Y	111.65	5064.6	612	1077	36	36	42	1140	30
53Z		5064.9	613	1077	21	27	1140	15
54X	111.70	5041.8	536	1078	12	12	18	1015	12
54W		5042.1	537	1078	24	30	1015	24
54Y	111.75	5065.2	614	1078	36	36	42	1141	30
54Z		5065.5	615	1078	21	27	1141	15
55X	111.80	1079	12	1016	12
55Y	111.85	5065.8	616	1079	36	36	42	1142	30
55Z		5066.1	617	1079	21	27	1142	15
56X	111.90	5042.4	538	1080	12	12	18	1017	12
56W		5042.7	539	1080	24	30	1017	24
56Y	111.95	5066.4	618	1080	36	36	42	1143	30
56Z		5066.7	619	1080	21	27	1143	15
57X	112.00	1081	12	1018	12
57Y	112.05	1081	36	1144	30
58X	112.10	1082	12	1019	12
58Y	112.15	1082	36	1145	30
59X	112.20	1083	12	1020	12
59Y	122.25	1083	36	1146	30
**60X		1084	12	1021	12
**60Y		1084	36	1147	30
**61X		1085	12	1022	12
**61Y		1085	36	1148	30
**62X		1086	12	1023	12
**62Y		1086	36	1149	30
**63X		1037	12	1024	12
**63Y		1087	36	1150	30
**64X		1088	12	1151	12
**64Y		1088	36	1025	30
**65X		1089	12	1152	12
**65Y		1089	36	1026	30
**66X		1090	12	1153	12
**66Y		1090	36	1027	30
**67X		1091	12	1154	12
**67Y		1091	36	1028	30
**68X		1092	12	1155	12
**68Y		1092	36	1029	30
**69X		1093	12	1156	12
**69Y		1093	36	1030	30
70X	112.30	1094	12	1157	12
**70Y	112.35	1094	36	1031	30
71X	112.40	1095	12	1158	12
**71Y	112.45	1095	36	1032	30
72X	112.50	1096	12	1159	12
**72Y	112.55	1096	36	1033	30

TABLE 1b—CHANNELS—Continued

Channel pairing				DME parameters					
DME No.	VHF freq. MHz	MLS angle freq. MHz	MLS Ch. No.	Interrogation			Reply		
				Freq. MHz	Pulse codes		Freq. MHz	Pulse codes μ s	
					DME/N μ s	DME/P Mode			
IA μ s	FA μ s								
73X	112.60			1097	12			1160	12
**73Y	112.65			1097	36			1034	30
74X	112.70			1098	12			1161	12
**74Y	112.75			1098	36			1035	30
75X	112.80			1099	12			1162	12
**75Y	112.85			1099	36			1036	30
76X	112.90			1100	12			1163	12
**76Y	112.95			1100	36			1037	30
77X	113.00			1101	12			1164	12
**77Y	113.05			1101	36			1038	30
78X	113.10			1102	12			1165	12
**78Y	113.15			1102	36			1039	30
79X	113.20			1103	12			1166	12
**79Y	113.25			1103	36			1040	30
80X	113.30			1104	12			1167	12
80Y	113.35	5067.0	620	1104	36	36	42	1041	30
80Z		5067.3	621	1104		21	27	1041	15
81X	113.40			1105	12			1168	12
81Y	113.45	5067.6	622	1105	36	36	42	1042	30
81Z		5067.9	623	1005		21	27	1042	15
82X	113.50			1106	12			1169	12
82Y	113.55	5068.2	624	1106	36	36	42	1043	30
82Z		5068.5	625	1106		21	27	1043	15
83X	113.60			1107	12			1170	12
83Y	113.65	5068.8	626	1107	36	36	42	1044	30
83Z		5069.1	627	1107		21	27	1044	15
84X	113.70			1108	12			1171	12
84Y	113.75	5069.4	628	1108	36	36	42	1045	30
84Z		6069.7	629	1108		21	27	1045	15
85X	113.80			1109	12			1172	12
85Y	113.85	5070.0	630	1109	36	36	42	1046	30
85Z		5070.3	631	1109		21	27	1046	15
86X	113.90			1110	12			1173	12
86Y	113.95	5070.6	632	1110	36	36	42	1047	30
86Z		5070.9	633	1110		21	27	1047	15
87X	114.00			1111	12			1174	12
87Y	114.05	5071.2	634	1111	36	36	42	1048	30
87Z		5071.5	635	1111		21	27	1048	15
88X	114.10			1112	12			1175	12
88Y	114.15	5071.8	636	1112	36	36	42	1049	30
88Z		5072.1	637	1112		21	27	1049	15
89X	114.20			1113	12			1176	12
89Y	114.25	5072.4	638	1113	36	36	42	1050	30
89Z		5072.7	639	1113		21	27	1050	15
90X	114.30			1114	12			1177	12
90Y	114.35	5073.0	640	1114	36	36	42	1051	30
90Z		5073.3	641	1114		21	27	1051	15
91X	114.40			1115	12			1178	12
91Y	114.45	5073.6	642	1115	36	36	42	1052	30
91Z		5073.9	643	1115		21	27	1052	15
92X	114.50			1116	12			1179	12
92Y	114.55	5074.2	644	1116	36	36	42	1053	30
92Z		5074.5	645	1116		21	27	1053	15
93X	114.60			1117	12			1180	12
93Y	114.65	5074.8	646	1117	36	36	42	1054	30
93Z		5075.1	647	1117		21	27	1054	15
94X	114.70			1118	12			1181	12
94Y	114.75	5075.4	648	1118	36	36	42	1055	30
94Z		5075.7	649	1118		21	27	1055	15
95X	114.80			1119	12			1182	12
95Y	114.85	5076.0	650	1119	36	36	42	1056	30
95Z		5076.3	651	1119		21	27	1056	15
96X	114.90			1120	12			1183	12
96Y	114.95	5076.6	652	1120	36	36	42	1057	30
96Z		5076.9	653	1120		21	27	1057	15

TABLE 1b—CHANNELS—Continued

Channel pairing				DME parameters					
DME No.	VHF freq. MHz	MLS angle freq. MHz	MLS Ch. No.	Interrogation			Reply		
				Freq. MHz	Pulse codes		Freq. MHz	Pulse codes μ s	
					DME/N μ s	DME/P Mode			
IA μ s	FA μ s								
97X	115.00			1121	12			1184	12
97Y	115.05	5077.2	654	1121	36	36	42	1058	30
97Z		5077.5	655	1121		21	27	1058	15
98X	115.10			1122	12			1185	12
98Y	115.15	5077.8	656	1122	36	36	42	1059	30
98Z		5078.1	657	1122		21	27	1059	15
99X	115.20			1123	12			1186	12
99Y	115.25	5078.4	658	1123	36	36	42	1060	30
99Z		5078.7	659	1123		21	27	1060	15
100X	115.30			1124	12			1187	12
100Y	115.35	5079.0	660	1124	36	36	42	1061	30
100Z		5079.3	661	1124		21	27	1061	15
101X	115.40			1125	12			1188	12
101Y	115.45	5079.6	662	1125	36	36	42	1062	30
101Z		5079.9	663	1125		21	27	1062	15
102X	115.50			1126	12			1189	12
102Y	115.55	5080.2	664	1126	36	36	42	1063	30
102Z		5080.5	665	1126		21	27	1063	15
103X	115.60			1127	12			1190	12
103Y	115.65	5080.8	666	1127	36	36	42	1064	30
103Z		5081.1	667	1127		21	27	1064	19
104X	115.70			1128	12			1191	12
104Y	115.75	5081.4	668	1128	36	36	42	1065	30
104Z		5081.7	669	1128		21	27	1065	19
105X	115.80			1129	12			1192	12
105Y	115.85	5082.0	670	1129	36	36	42	1066	30
105Z		5082.3	671	1129		21	27	1066	15
106X	115.90			1130	12			1193	12
106Y	115.95	5082.6	672	1130	36	36	42	1067	30
106Z		5082.9	673	1130		21	27	1067	15
107X	116.00			1131	12			1194	12
107Y	116.05	5083.2	674	1131	36	36	42	1068	30
107Z		5083.5	675	1131		21	27	1068	15
108X	116.10	508		1132	12			1195	12
108Y	116.15	5083.8	676	1132	36	36	42	1069	30
108Z		5084.1	677	1132		21	27	1069	15
109X	116.20			1133	12			1196	12
109Y	116.25	5084.4	678	1133	36	36	42	1070	30
109Z		5084.7	679	1133		21	27	1070	15
110X	116.30			1134	12			1197	12
110Y	116.35	5085.0	680	1134	36	36	42	1071	30
110Z		5085.3	681	1134		21	27	1071	15
111X	116.40			1135	12			1198	12
111Y	116.45	5086.6	682	1135	36	36	42	1072	30
111Z		5085.9	683	1135		21	27	1072	15
112X	116.50			1136	12			1199	12
112Y	116.55	5086.2	684	1136	36	36	42	1073	30
112Z		5086.5	685	1136		21	27	1073	15
113X	116.60			1137	12			1200	12
113Y	116.65	5086.8	686	1137	36	36	42	1074	30
113Z		5087.1	687	1137		21	27	1074	15
114X	116.70			1138	12			1201	12
114Y	116.75	5087.4	688	1138	36	36	42	1075	30
114Z		5087.7	689	1138		21	27	1075	15
115X	116.80			1139	12			1202	12
115Y	116.85	5088.0	690	1139	36	36	42	1076	30
115Z		5088.3	691	1139		21	27	1076	15
116X	116.90			1140	12			1203	12
116Y	116.95	5088.6	692	1140	36	36	42	1077	30
116Z		5088.9	693	1140		21	27	1077	15
117X	117.00			1141	12			1204	12
117Y	117.05	5089.2	694	1141	36	36	42	1078	30
117Z		5089.5	695	1141		21	27	1078	15
118X	117.10			1142	12			12.5	12
118Y	117.15	5089.8	696	1142	36	36	42	1079	30

TABLE 1b—CHANNELS—Continued

Channel pairing				DME parameters					
DME No.	VHF freq. MHz	MLS angle freq. MHz	MLS Ch. No.	Interrogation			Reply		
				Freq. MHz	Pulse codes				
					DME/N μ s	IA μ s	FA μ s	Freq. MHz	Pulse codes μ s
118Z	5090.1	697	1142	21	27	1079	12
119X	117.20	1143	12	1206	12
119Y	117.25	5090.4	698	1143	36	36	42	1080	30
119Z	5090.7	699	1143	21	27	1080	15
120X	117.30	1144	12	1207	12
120Y	117.35	1144	36	1081	30
121X	117.40	1145	12	1208	12
121Y	117.45	1145	36	1082	30
122X	117.50	1146	12	1209	12
122Y	117.55	1146	36	1083	30
123X	117.60	1147	12	1210	12
123Y	117.65	1147	36	1084	30
124X	117.70	1148	12	1211	12
**124Y	117.75	1148	36	1085	30
125X	117.80	1149	12	1212	12
**125Y	117.85	1149	36	1086	30
126X	117.90	1150	12	1213	12
**126Y	117.95	1150	36	1087	30

Notes:
 * These channels are reserved exclusively for national allotments.
 ** These channels may be used for national allotment on a secondary basis. The primary reason for reserving these channels is to provide protection for the secondary Surveillance Radar (SSR) system.
 ∇ 108.0 MHz is not scheduled for assignment to ILS service. The associated DME operating channel No. 17X may be assigned to the emergency service.

(b) *Polarization.* (1) The radio frequency emissions from all ground equipment must be nominally vertically polarized. Any horizontally polarized radio frequency emission component from the ground equipment must not have incorrectly coded angle information such that the limits specified in paragraphs (b) (2) and (3) of this section are exceeded.

(2) Rotation of the receiving antenna thirty degrees from the vertically polarized position must not cause the path following error to exceed the allowed error at that location.

(c) *Modulation requirements.* Each function transmitter must be capable

of DPSK and continuous wave (CW) modulations of the RF carrier which have the following characteristics.

(1) DPSK. The DPSK signal must have the following characteristics:

bit rate	15.625 KHz
bit length	64 microseconds
logic "0"	no phase transition
logic "1"	phase transition
phase transition	less than 10 microseconds
phase tolerance	±10 degrees

The phase shall advance (or retard) monotonically throughout the transition region. Amplitude modulation during the phase transition period shall not be used.

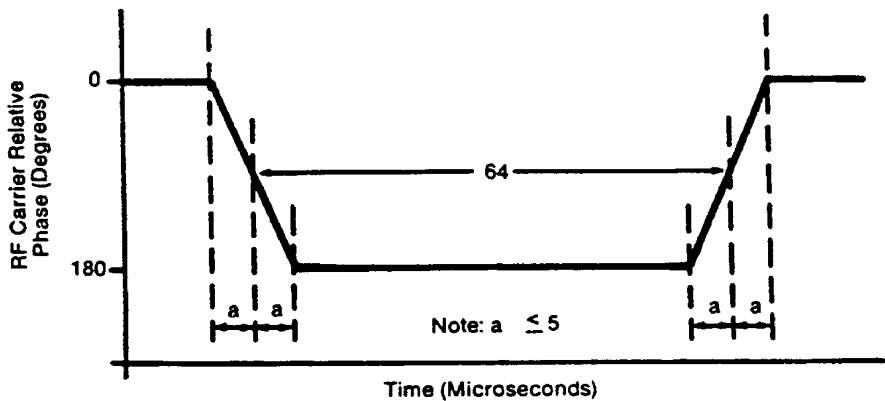

Figure 1.-DPSK Phase Characteristic

(2) CW. The CW pulse transmissions and the CW angle transmissions as may be required in the signal format of any function must have characteristics such that the requirements of paragraph (d) of this section are met.

(d) *Radio frequency signal spectrum.* The transmitted signal must be such that during the transmission time, the mean power density above a height of 600 meters (2000 feet) does not exceed -100.5 dBW/m^2 for angle guidance and -95.5 dBW/m^2 for data, as measured in a 150 KHz bandwidth centered at a frequency of 840 KHz or more from the assigned frequency.

(e) *Synchronization.* Synchronization between the azimuth and elevation components is required and, in split-site configurations, would normally be accomplished by landline interconnections. Synchronization monitoring must be provided to preclude function overlap.

(f) *Transmission rates.* Angle guidance and data signals must be transmitted at the following average repetition rates:

Function	Average data rate (Hertz)
Approach Azimuth	13 ±0.5
High Rate Approach Azimuth	139 ±1.5
Approach Elevation	39 ±1.5
Back Azimuth	6.5 ±0.25
Basic Data	(²)
Auxiliary Data	(³)

¹ The higher rate is recommended for azimuth scanning antennas with beamwidths greater than two degrees. It should be noted that the time available in the signal format for additional functions is limited when the higher rate is used.

² Refer to Table 8a.

³ Refer to Table 8c.

(g) *Transmission sequences.* Sequences of angle transmissions which will generate the required repetition rates are shown in Figures 2 and 3.

Sequence #1	Time (ms)	Sequence #2
Approach Elevation	0	Approach Elevation
Flare		Flare
Approach Azimuth	20	Approach Azimuth
Flare		Flare
Approach Elevation	30	Approach Elevation
Flare		Flare
Back Azimuth	50	Growth (18.2ms Max) (Note 2)
(Note 2)		
Approach Elevation	60	Approach Elevation
Flare		Flare
	66.7	66.8

(Note 3)

Notes:

1. When Back Azimuth is Provided, Basic Data Word # 2 Must Be Transmitted Only In This Position.
2. Data Words May Be Transmitted In Any Open Time Periods.
3. The Total Time Duration of Sequence #1 Plus Sequence #2 Must Not exceed 134 ms.

Figure 2. Transmission sequence pair which provides for all MLS angle guidance functions.

Sequence #1	Time (ms)	Sequence #2
Approach Elevation	0	Approach Elevation
High Rate Approach Azimuth	10	High Rate Approach Azimuth
Data Words (Note 1)	20	(Note 2)
High Rate Approach Azimuth	30	Back Azimuth
Approach Elevation	40	High Rate Approach Azimuth
High Rate Approach Azimuth	50	Approach Elevation
Approach Elevation	60	High Rate Approach Azimuth
Approach Elevation	64.9	Approach Elevation
	67.5	Approach Elevation

(Note 3)

Notes:

1. Data Words May Be Transmitted In Any Open Time Period.
2. When Back Azimuth Is Provided, Basic Data Word #2 Must Be Transmitted Only In This Position.
3. The Total Time Duration Of Sequence #1 Plus Sequence #2 Must Not Exceed 134 ms.

Figure 3. Transmission sequence pair which provides for the MLS high rate approach azimuth angle guidance function.

(h) *TDM cycle*. The time periods between angle transmission sequences must be varied so that exact repetitions do not occur within periods of less than 0.5 second in order to protect against synchronous interference. One

such combination of sequences is shown in Figure 4 which forms a full multiplex cycle. Data may be transmitted during suitable open times within or between the sequences.

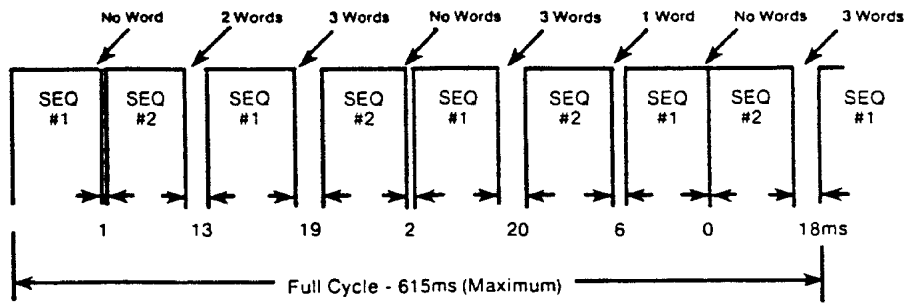

Note: Angle Sequence Are Those From Figure 2 Or 3. Do Not Mix Sequences.

Figure 4. A complete function multiplex cycle.

(i) *Function Formats (General)*. Each angle function must contain the following elements: a preamble; sector signals; and a TO and FRO angle scan organized as shown in Figure 5a. Each data function must contain a preamble and a data transmission period organized as shown in Figure 5b.

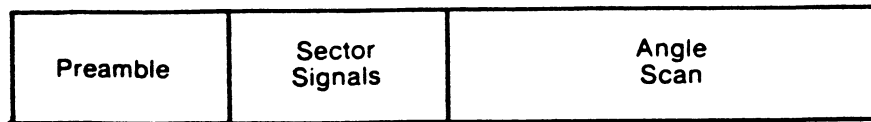

(a) Angle Function

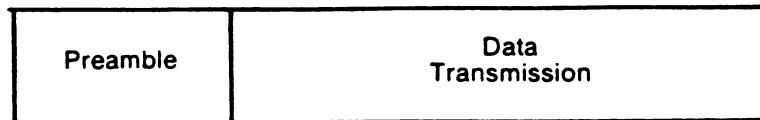

(b) Data Function

Figure 5 - Function format.

(1) *Preamble format*. The transmitted angle and date functions must use the preamble format shown in Figure 6. This format consists of a carrier acquisition period of unmodulated CW transmission followed by a receiver synchronization code and a function identification code. The preamble timing must be in accordance with Table 2.

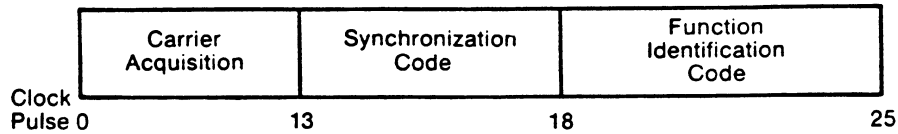

Figure 6 - Preamble organization.

(i) *Digital codes.* The coding used in the preamble for receiver synchronization is a Barker code logic 11101. The time of the last phase transition midpoint in the code shall be the receiver reference time (see Table 2). The function identification codes must be as shown in Table 3. The last two bits (I_{11} and I_{12}) of the code are parity bits obeying the equations:

$$I_6 + I_7 + I_8 + I_9 + I_{10} + I_{11} = \text{Even}$$

$$I_6 + I_8 + I_{10} + I_{12} = \text{Even}$$

(ii) *Data modulation.* The digital code portions of the preamble must be DPSK modulated in accordance with §171.311(c)(1) and must be transmitted throughout the function coverage volume.

(2) *Angle function formats.* The timing of the angle transmissions must be in accordance with Tables 4a, 4b, and 5. The actual timing of the TO and FRO scans must be as required to meet the accuracy requirements of §§171.313 and 171.317.

(i) Preamble. Must be in accordance with requirements of §171.311(i)(1).

TABLE 2—PREAMBLE TIMING ¹

Event	Event time slot begins at—	
	15.625 kHz clock pulse (number)	Time (milliseconds)
Carrier acquisition: (CW transmission)	0	0
Receiver reference time code:		
$I_1 = 1$	13	0.832
$I_2 = 1$	14	0.896
$I_3 = 1$	15	0.960
$I_4 = 0$	16	1.024
$I_5 = 1$	17	² 1.088
Function identification:		
I_6	18	1.152
I_7	19	1.216
I_8	20	1.280
I_9	21	1.344
I_{10} (see table 1)	22	1.408
I_{11}	23	1.472
I_{12}	24	1.536

TABLE 2—PREAMBLE TIMING ¹—Continued

Event	Event time slot begins at—	
	15.625 kHz clock pulse (number)	Time (milliseconds)
END PREAMBLE	25	1.600

¹ Applies to all functions transmitted.
² Reference time for receiver synchronization for all function timing.

TABLE 3—FUNCTION IDENTIFICATION CODES

Function	Code						
	I_6	I_7	I_8	I_9	I_{10}	I_{11}	I_{12}
Approach azimuth	0	0	1	1	0	0	1
High rate approach azimuth	0	0	1	0	1	0	0
Approach elevation	1	1	0	0	0	0	1
Back azimuth	1	0	0	1	0	0	1
Basic data 1	0	1	0	1	0	0	0
Basic data 2	0	1	1	1	1	0	0
Basic data 3	1	0	1	0	0	0	0
Basic data 4	1	0	0	0	1	0	0
Basic data 5	1	1	0	1	1	0	0
Basic data 6	0	0	0	1	1	0	1
Auxiliary data A	1	1	1	0	0	1	0
Auxiliary data B	1	0	1	0	1	1	1
Auxiliary data C	1	1	1	1	0	0	0

(ii) *Sector signals.* In all azimuth formats, sector signals must be transmitted to provide Morse Code identification, airborne antenna selection, and system test signals. These signals are not required in the elevation formats. In addition, if the signal from an installed ground component results in a valid indication in an area where no valid guidance should exist, OCI signals must be radiated as provided for in the signal format (see Tables 4a, 4b, and 5). The sector signals are defined as follows:

(A) *Morse Code.* DPSK transmissions that will permit Morse Code facility identification in the aircraft by a four letter code starting with the letter ‘M’ must be included in all azimuth functions. They must be transmitted and repeated at approximately equal intervals, not less than six times per

§ 171.311

14 CFR Ch. I (1-1-24 Edition)

minute, during which time the ground subsystem is available for operational use. When the transmissions of the ground subsystem are not available, the identification signal must be suppressed. The audible tone in the aircraft is started by setting the Morse Code bit to logic “1” and stopped by a logic “0” (see Tables 4a and 4b). The identification code characteristics must conform to the following: the dot must be between 0.13 and 0.16 second in duration, and the dash between 0.39 and 0.48 second. The duration between dots and/or dashes must be one dot plus or minus 10%. The duration between characters (letters) must not be less than three dots. When back azimuth is provided, the code shall be transmitted by the approach azimuth and back azimuth within plus or minus 0.08 seconds.

(B) *Airborne antenna selection.* A signal for airborne antenna selection shall be transmitted as a “zero” DPSK signal lasting for a six-bit period (see Tables 4a and 4b).

TABLE 4a—APPROACH AZIMUTH FUNCTION TIMING

Event	Event time slot begins at—	
	15.625 kHz clock pulse (number)	Time (milliseconds)
Preamble	0	0
Morse code	25	1.600
Antenna select	26	1.664
Rear OCI	32	2.048
Left OCI	34	2.176
Right OCI	36	2.304
To test	38	2.432
To scan ¹	40	2.560
Pause	8.760
Midscan point	9.060
FRO scan ¹	9.360
FRO test	15.560
End Function (Airborne)	15.688
End guard time; end function (ground)	15.900

¹ AA¹ The actual commencement and completion of the TO and the FRO scan transmissions are dependent on the amount of proportional guidance provided. The time slots provided shall accommodate a maximum scan of plus or minus 62.0 degrees. Scan timing shall be compatible with accuracy requirements.

TABLE 4b—HIGH RATE APPROACH AZIMUTH AND BACK AZIMUTH FUNCTION TIMING

Event	Event time slot begins at—	
	15.625 kHz clock pulse (number)	Time (milliseconds)
Preamble	0	0
Morse Code	25	1.600
Antenna select	26	1.664
Rear OCI	32	2.048
Left OCI	34	2.176
Right OCI	36	2.304
To test	38	2.432
To scan ¹	40	2.560
Pause	6.760
Midscan point	7.060
FRO scan ¹	7.360
FRO test pulse	11.560
End function (airborne)	11.688
End guard time; end function (ground)	11.900

¹ The actual commencement and completion of the TO and the FRO scan transmissions are dependent on the amount of proportional guidance provided. The time slots provided will accommodate a maximum scan of plus or minus 42.0 degrees. Scan timing shall be compatible with accuracy requirements.

(C) *OCI.* Where OCI pulses are used, they must be: (1) greater than any guidance signal in the OCI sector; (2) at least 5 dB less than the level of the scanning beam within the proportional guidance sector; and (3) for azimuth functions with clearance signals, at least 5 dB less than the level of the left (right) clearance pulses within the left (right) clearance sector.

TABLE 5—APPROACH ELEVATION FUNCTION TIMING

Event	Event time slot begins at:	
	15.625 kHz clock pulse (number)	Time (milliseconds)
Preamble	0	0
Processor pause	25	1.600
OCI	27	1.728
To scan ¹	29	1.856
Pause	3.406
Midscan point	3.606
FRO scan ¹	3.806
End function (airborne)	5.356
End guard time; end function (ground)	5.600

¹ The actual commencement and completion of the TO and FRO scan transmissions are dependent upon the amount of proportional guidance provided. The time slots provided will accommodate a maximum scan of -1.5 degrees to +29.5 degrees. Scan timing shall be compatible with accuracy requirements.

The duration of each pulse measured at the half amplitude point shall be at least 100 microseconds, and the rise and

fall times shall be less than 10 microseconds. It shall be permissible to sequentially transmit two pulses in each out-of-coverage indication time slot. Where pulse pairs are used, the duration of each pulse shall be at least 50 microseconds, and the rise and fall times shall be less than 10 microseconds. The transmission of out-of-coverage indication pulses radiated from antennas with overlapping coverage patterns shall be separated by at least 10 microseconds.

NOTE: If desired, two pulses may be sequentially transmitted in each OCI time slot. Where pulse pairs are used, the duration of each pulse must be 45 (± 5) microseconds and the rise and fall times must be less than 10 microseconds.

(D) *System test.* Time slots are provided in Tables 4a and 4b to allow radiation of TO and FRO test pulses. However, radiation of these pulses is not required since the characteristics of these pulses have not yet been standardized.

(iii) *Angle encoding.* The encoding must be as follows:

(A) *General.* Azimuth and elevation angles are encoded by scanning a narrow beam between the limits of the

proportional coverage sector first in one direction (the TO scan) and then in the opposite direction (the FRO scan). Angular information must be encoded by the amount of time separation between the beam centers of the TO and FRO scanning beam pulses. The TO and FRO transmissions must be symmetrically disposed about the midscan point listed in Tables 4a, 4b, 5, and 7. The midscan point and the center of the time interval between the TO and FRO scan transmissions must coincide with a tolerance of ± 10 microseconds. Angular coding must be linear with angle and properly decoded using the formula:

$$\theta = \frac{V}{2}(T_0 - t)$$

where:

θ = Receiver angle in degrees.

V = Scan velocity in degrees per microsecond.

T_0 = Time separation in microseconds between TO and FRO beam centers corresponding to zero degrees.

t = Time separation in microseconds between TO and FRO beam centers.

The timing requirements are listed in Table 6 and illustrated in Figure 7.

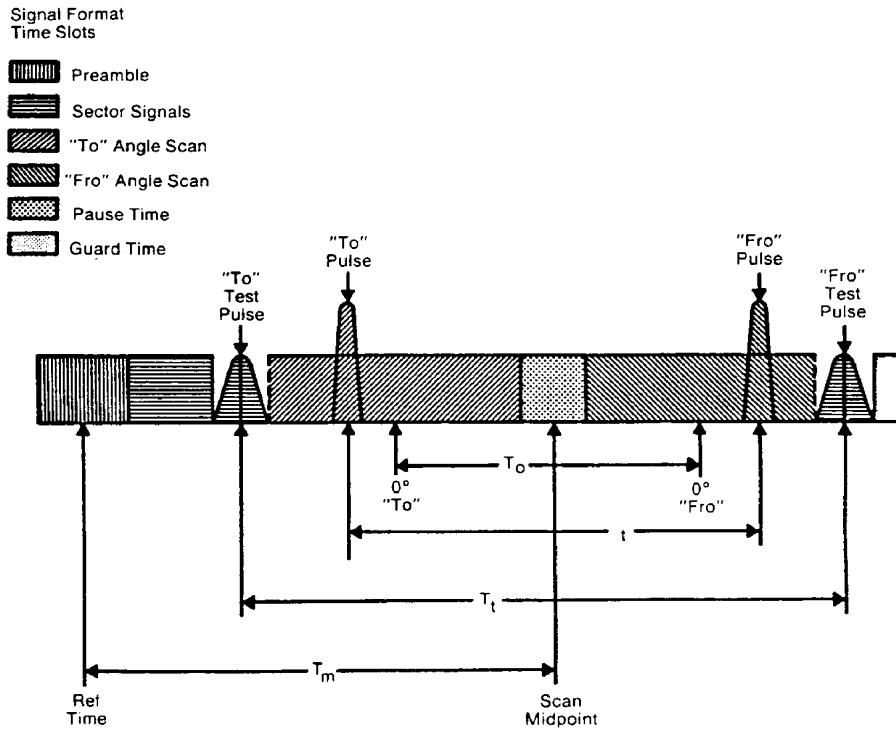

Figure 7. Azimuth Angle Scan Timing (Not to Scale)

(B) *Azimuth angle encoding.* Each guidance angle transmitted must consist of a clockwise TO scan followed by a counterclockwise FRO scan as viewed from above the antenna. For approach azimuth functions, increasing angle values must be in the direction of the TO scan; for the back azimuth function, increasing angle values must be in the direction of the FRO scan. The antenna has a narrow beam in the plane of the scan direction and a broad beam in the orthogonal plane which fills the vertical coverage.

(C) *Elevation angle encoding.* The radiation from elevation equipment must produce a beam which scans from the horizon up to the highest elevation angle and then scans back down to the horizon. The antenna has a narrow beam in the plane of the scan direction and a broad beam in the orthogonal plane which fills the horizontal cov-

erage. Elevation angles are defined from the horizontal plane containing the antenna phase center; positive angles are above the horizontal and zero angle is along the horizontal.

(iv) *Clearance guidance.* The timing of the clearance pulses must be in accordance with Figure 8. For azimuth elements with proportional coverage of less than ± 40 degrees (± 20 degrees for back azimuth), clearance guidance information must be provided by transmitting pulses in a TO and FRO format adjacent to the stop/start times of the scanning beam signal. The fly-right clearance pulses must represent positive angles and the fly-left clearance pulses must represent negative angles. The duration of each clearance pulse must be 50 microseconds with a tolerance of ± 5 microseconds. The transmitter switching time between the clearance pulses and the scanning

beam transmissions must not exceed 10 microseconds. The rise time at the edge of each clearance pulse must be less than 10 microseconds. Within the fly-right clearance guidance section, the fly-right clearance guidance signal shall exceed scanning beam antenna sidelobes and other guidance and OCI signals by at least 5 dB; within the fly-left clearance guidance sector, the fly left clearance guidance signal shall exceed scanning beam antenna sidelobes and all other guidance and OCI signals by at least 5 dB; within the proportional guidance sector, the clearance guidance signals shall be at least 5dB below the proportional guidance signal. Optionally, clearance guidance may be provided by scanning throughout the approach guidance sector. For angles outside the approach azimuth proportional coverage limits as set in Basic Data Word One (Basic Data Word 5 for back azimuth), proper decode and display of clearance guidance must occur to the limits of the guidance region.

Where used, clearance pulses shall be transmitted adjacent to the scanning beam signals at the edges of proportional coverage as shown in Figure 8. The proportional coverage boundary shall be established at one beamwidth inside the scan start/stop angles, such that the transition between scanning beam and clearance signals occurs outside the proportional coverage sector. When clearance pulses are provided in conjunction with a narrow beamwidth (e.g., one degree) scanning antenna, the scanning beam antenna shall radiate for 15 microseconds while stationary at the scan start/stop angles.

(3) *Data function format.* Basic data words provide equipment characteristics and certain siting information. Basic data words must be transmitted from an antenna located at the approach azimuth or back azimuth site which provides coverage throughout the appropriate sector. Data function timing must be in accordance with Table 7a.

TABLE 6—ANGLE SCAN TIMING CONSTANTS

Function	Max value of T_r (usec)	T_a (usec)	V(deg/usec)	T_m (usec)	Pause time (usec)	T_i (usec)
Approach azimuth	13,000	6,800	0.02	7,972	600	13,128
High rate approach azimuth	9,000	4,800	0.02	5,972	600	9,128
Approach elevation	3,500	3,350	0.02	2,518	400	N/A
Back azimuth	9,000	4,800	-0.02	5,972	600	9,128

TABLE 7a—BASIC DATA FUNCTION TIMING

Event	Event time slot begins at: ¹	
	15.625 kHz clock pulse (number)	Time (milliseconds)
Preamble	0	0
Data transmission (bits I_{13} – I_{30})	25	1,600
Parity transmission (bits I_{31} – I_{32})	43	2,752
End function (airborne)	45	2,880
End guard time: end function (ground)		3,100

¹ The previous event time slot ends at this time.

TABLE 7b—AUXILIARY DATA FUNCTION TIMING—(DIGITAL)

Event	Event time slot begins at:	
	15.625 kHz clock pulse (number)	Time (milliseconds)
Preamble	0	0
Address transmission (bits I_{13} – I_{20})	25	1,600
Data transmission: (bits I_{21} – I_{69})	33	2,112

TABLE 7b—AUXILIARY DATA FUNCTION TIMING—(DIGITAL)—Continued

Event	Event time slot begins at:	
	15.625 kHz clock pulse (number)	Time (milliseconds)
Parity transmission (bits I_{70} – I_{76})	82	5,248
End function (airborne)	89	5,696
End guard time: end function (ground)		5,900

TABLE 7c—AUXILIARY DATA FUNCTION TIMING—(ALPHANUMERIC)

Event	Event time slot begins at:	
	15.615 kHz clock pulse (number)	Time (milliseconds)
Preamble	0	0
Address transmission (bits I_{13} – I_{20})	25	1,600
Data transmission: (bits I_{21} – I_{76})	33	2,112
End function (airborne)	89	5,696

§ 171.311

14 CFR Ch. I (1–1–24 Edition)

TABLE 7c—AUXILIARY DATA FUNCTION TIMING—
(ALPHANUMERIC)—Continued

Event	Event time slot begins at:	
	15.615 kHz clock pulse (number)	Time (milli-seconds)
End guard time; (end function ground)	5.900

(i) *Preamble.* Must be in accordance with requirements of §171.311(i)(1).

(ii) *Data transmissions.* Basic data must be transmitted using DPSK modulation. The content and repetition rate of each basic data word must be in accordance with Table 8a. For data containing digital information, binary number 1 must represent the lower range limit with increments in binary steps to the upper range limit shown in Table 8a. Data containing digital information shall be transmitted with the least significant bit first.

(j) *Basic Data word requirements.* Basic Data shall consist of the items specified in Table 8a. Basic Data word contents shall be defined as follows:

(1) *Approach azimuth to threshold distance* shall represent the minimum distance between the Approach Azimuth antenna phase center and the vertical plane perpendicular to the centerline which contains the landing threshold.

(2) *Approach azimuth proportional coverage limit* shall represent the limit of the sector in which proportional approach azimuth guidance is transmitted.

(3) *Clearance signal type* shall represent the type of clearance when used. Pulse clearance is that which is in accordance with §171.311 (i) (2) (iv). Scanning Beam (SB) clearance indicates that the proportional guidance sector is limited by the proportional coverage limits set in basic data.

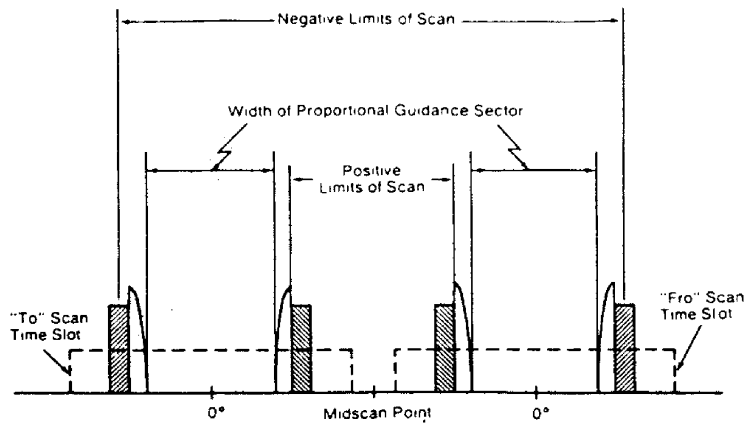

(a) APPROACH AZIMUTH

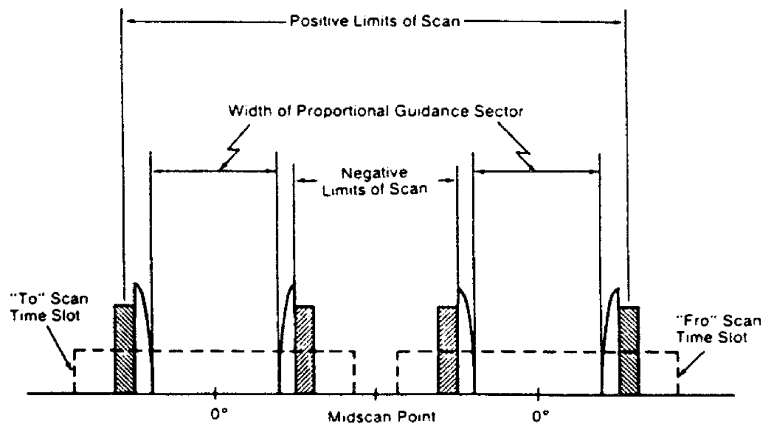

(b) BACK AZIMUTH

Legend





Clearance Pulses	Scanning Beam Pulses
 Fly-Left	 Start Scan
 Fly-Right	 Stop Scan

Figure 8. Clearance Pulse Timing for Azimuth Functions

TABLE 8a—BASIC DATA WORDS

Data bit #	Data item definition	LSB value	Data bit value
Basic Data Word No. 1			
1	Preamble	N/A	1
2	1	1
3	1	1
4	0	0
5	1	1
6	0	0
7	1	1
8	0	0
9	1	1
10	0	0
11	0	0
12	0	0
13	Approach azimuth to threshold distance (Om – 630m).	100m	100m
14		200m
15		400m
16		800m
17		1600m
18		3200m
19	Approach azimuth proportional coverage limit (negative limit) (0° to – 62°).	2°	–2°
20		–4°
21		–8°
22		–16°
23		–32°
24	Approach azimuth proportional coverage limit (positive limit) (0° to + 62°).	2°	2°
25		4°
26		8°
27		16°
28		32°
29	Clearance signal type	N/A	0 = pulse; 1 = SB
30	Spare		Transmit zero
31	Parity: (13 + 14 + 15. . . + 30 + 31 = odd).	N/A	N/A
32	Parity: (14 + 16 + 18. . . + 30 + 32 = odd).	N/A	N/A

Note 1: Transmit throughout the Approach Azimuth guidance sector at intervals of 1.0 seconds or less.

Note 2: The all zero state of the data field represents the lower limit of the absolute value of the coded parameter unless otherwise noted.

Basic Data Word No. 2

Data bit #	Data item definition	LSB value	Data bit value
1	Preamble	N/A	1
2	1	1
3	1	1
4	0	0
5	1	1
6	0	0
7	1	1
8	1	1
9	1	1
10	1	1
11	0	0
12	0	0
13	Minimum glide path (2.0° to 14.7°).	0.1°	0.1°
14		0.2°
15		0.4°
16		0.8°

TABLE 8a—BASIC DATA WORDS—Continued

Data bit #	Data item definition	LSB value	Data bit value
17		1.6°
18		3.2°
19		6.4°
20	Back azimuth status		see note 4
21	DME status		see note 6
22		
23	Approach azimuth status		see note 4
24	Approach azimuth status		see note 4
25	Spare		Transmit zero
26do		Do.
27do		Do.
28do		Do.
29do		Do.
30do		Do.
31	Parity: (13 + 14 + 15. . . + 30 + 31) = odd).	N/A	N/A
32	Parity: (14 + 16 + 18. . . + 30 + 32 = odd).	N/A	N/A

Note 1: Transmit throughout the Approach Azimuth guidance sector at intervals of 0.16 seconds or less.

Note 2: The all zero state of the data field represents the lower limit of the absolute range of the coded parameter unless otherwise noted.

Basic Data Word No. 3

Data bit #	Data item definition	LSB value	Data bit value
1	Preamble	N/A	1
2	1	1
3	1	1
4	0	0
5	1	1
6	1	1
7	0	0
8	1	1
9	0	0
10	0	0
11	0	0
12	0	0
13	Approach azimuth beamwidth (0.5° – 4.0°) See note 7.	0.5°	0.5°
14		1.0°
15		2.0°
16	Approach elevation beamwidth (0.5° to 2.5°) See note 7.	0.5°	0.5°
17		1.0°
18	Note: values greater than 2.5° are invalid.		2.0°
19	DME distance (Om to 6387.5m).	12.5m	12.5m
20		25.0m
21		50.0m
22		100.0m
23		200.0m
24		400.0m
25		800.0m
26		1600.0m
27		3200.0m
28	Spare		Transmit zero
29do		Do.
30do		Do.
31	Parity: (13 + 14 + 15. . . + 30 + 31 = odd).		
32	Parity: (14 + 16 + 18. . . + 30 + 32 = odd).	N/A	N/A

TABLE 8a—BASIC DATA WORDS—Continued

Data bit #	Data item definition	LSB value	Data bit value
<i>Note 1:</i> Transmit throughout the Approach Azimuth guidance sector at intervals of 1.0 seconds or less.			
<i>Note 2:</i> The all zero state of the data field represents the lower limit of the absolute range of the coded parameter unless otherwise noted.			

Basic Data Word No. 4

Data bit #	Data item definition	LSB value	Data bit value
1	Preamble	N/A	1
2	1	1
3	1	1
4	0	0
5	1	1
6	1	1
7	0	0
8	0	0
9	0	0
10	1	1
11	0	0
12	0	0
13	Approach azimuth magnetic orientation (0° to 359°).	1°	1°
14	2°	2°
15	4°	4°
16	8°	8°
17	16°	16°
18	32°	32°
19	64°	64°
20	128°	128°
21	256°	256°
22	Back azimuth magnetic orientation (0° to 359°).	1°	1°
23	2°	2°
24	4°	4°
25	8°	8°
26	16°	16°
27	32°	32°
28	64°	64°
29	128°	128°
30	256°	256°
31	Parity: (13 + 14 + 15. . . + 30 + 31 = odd).	N/A	N/A
32	Parity: (14 + 16 + 18. . . + 30 + 32 = odd).	N/A	N/A

Note 1: Transmit at intervals of 1.0 second or less throughout the Approach Azimuth guidance sector, except when Back Azimuth guidance is provided. See Note 8.

Note 2: The all zero state of the data field represents the lower limit of the absolute range of the coded parameter unless otherwise noted.

Basic Data Word No. 5

Data bit #	Data item definition	LSB value	Data bit value
1	Preamble	N/A	1
2	1	1
3	1	1
4	0	0
5	1	1
6	1	1
7	1	1
8	0	0
9	1	1
10	1	1
11	0	0
12	0	0
13	Back azimuth proportional coverage negative limit (0° to -42°).	2°	-2°
14	4°	-4°
15	8°	-8°

TABLE 8a—BASIC DATA WORDS—Continued

Data bit #	Data item definition	LSB value	Data bit value
16	-16°
17	-32°
18	Back azimuth proportional coverage positive limit (0° to +42°).	2°	2°
19	4°
20	8°
21	16°
22	32°
23	Back azimuth beamwidth (0.5° to 4.0°) See note 7.	0.5°	0.5°
24	1.0°
25	2.0°
26	Back azimuth status	See Note 10
27do	Do.
28do	Do.
29do	Do.
30do	Do.
31	Parity: (13 + 14 + 15. . . + 30 + 31 = odd).	N/A	N/A
32	Parity: (14 + 16 + 18. . . + 30 + 32 = odd).	N/A	N/A

Data bit #	Data item definition	LSB value	Data bit value
<i>Note 1:</i> Transmit only when Back Azimuth guidance is provided. See note 9.			
<i>Note 2:</i> The all zero state of the data field represents the lower limit of the absolute range of the coded parameter unless otherwise noted.			

Basic Data Word No. 6

Data bit #	Data item definition	LSB value	Data bit value
1	Preamble	N/A	1
2	1
3	1
4	0
5	1
6	0
7	0
8	0
9	1
10	1
11	0
12	1
(13–30)	MLS ground equipment identification (Note 3).
13	Character 2	N/A	B1
14	B2
15	B3
16	B4
17	B5
18	B6
19	Character 3	N/A	B1
20	B2
21	B3
22	B4
23	B5
24	B6
25	Character 4	N/A	B1
26	B2
27	B3
28	B4
29	B5
30	B6
31	Parity: (13 + 14 + 15. . . + 30 + 31 = odd).	N/A	N/A
32	Parity: (14 + 16 + 18. . . + 30 + 32 = odd).	N/A	N/A

Note 1: Transmit at intervals of 1.0 second or less throughout the Approach Azimuth guidance sector, except when Back Azimuth guidance is provided. See note 8.

§ 171.311

14 CFR Ch. I (1–1–24 Edition)

Note 3: Characters are encoded using the International Alphabet Number 5, (IA-5):

Note 4: Coding for status bit:
0 = Function not radiated, or radiated in test mode (not reliable for navigation).

1 = Function radiated in normal mode (for Back Azimuth, this also indicates that a Back Azimuth transmission follows).

Note 5: Data items which are not applicable to a particular ground equipment shall be transmitted as all zeros.

Note 6: Coding for status bits:

l_{21}	l_{22}	
0	0	DME transponder inoperative or not available.
1	0	Only IA mode or DME/N available.
0	0	FA mode, Standard 1, available.
1	1	FA mode, Standard 2, available.

Note 7: The value coded shall be the actual beamwidth (as defined in § 171.311 (j)(9) rounded to the nearest 0.5 degree.

Note 8: When back Azimuth guidance is provided, Data Words 4 and 6 shall be transmitted at intervals of 1.33 seconds or less throughout the Approach Azimuth coverage and 4 seconds or less throughout the Back Azimuth coverage.

Note 9: When Back Azimuth guidance is provided, Data Word 5 shall be transmitted at an interval of 1.33 seconds or less throughout the Back Azimuth coverage sector and 4 seconds or less throughout the Approach Azimuth coverage sector.

Note 10: Coding for status bit:
0 = Function not radiated, or radiated in test mode (not reliable for navigation).

1 = Function radiated in normal mode.

(4) *Minimum glidepath* the lowest angle of descent along the zero degree azimuth that is consistent with published approach procedures and obstacle clearance criteria.

(5) *Back azimuth status* shall represent the operational status of the Back Azimuth equipment.

(6) *DME status* shall represent the operational status of the DME equipment.

(7) *Approach azimuth status* shall represent the operational status of the approach azimuth equipment.

(8) *Approach elevation status* shall represent the operational status of the approach elevation equipment.

(9) *Beamwidth* the width of the scanning beam main lobe measured at the -3 dB points and defined in angular units on the antenna boresight, in the horizontal plane for the azimuth function and in the vertical plane for the elevation function.

(10) *DME distance* shall represent the minimum distance between the DME antenna phase center and the vertical plane perpendicular to the runway centerline which contains the MLS datum point.

(11) *Approach azimuth magnetic orientation* shall represent the angle measured in the horizontal plane clockwise from Magnetic North to the zero-degree angle guidance radial originating from the approach azimuth antenna phase center. The vertex of the meas-

ured angle shall be at the approach azimuth antenna phase center.

NOTE: For example, this data item would be encoded 090 for an approach azimuth antenna serving runway 27 (assuming the magnetic heading is 270 degrees) when sited such that the zero degree radial is parallel to centerline.

(12) *Back azimuth magnetic orientation* shall represent the angle measured in the horizontal plane clockwise from Magnetic North to the zero-degree angle guidance radial originating from the Back Azimuth antenna. The vertex of the measured angle shall be at the Back Azimuth antenna phase center.

NOTE: For example, this data item would be encoded 270 for a Back Azimuth Antenna serving runway 27 (assuming the magnetic heading is 270 degrees) when sited such that the zero degree radial is parallel to centerline.

(13) *Back azimuth proportional coverage limit* shall represent the limit of the sector in which proportional back azimuth guidance is transmitted.

(14) *MLS ground equipment identification* shall represent the last three characters of the system identification specified in §171.311(i)(2). The characters shall be encoded in accordance with International Alphabet No. 5 (IA-5) using bits b_1 through b_6 .

NOTE: Bit b_7 of this code may be reconstructed in the airborne receiver by taking the complement of bit b_6 .

(k) *Residual radiation*. The residual radiation of a transmitter associated with an MLS function during time intervals when it should not be transmitting shall not adversely affect the reception of any other function. The residual radiation of an MLS function at times when another function is radiating shall be at least 70 dB below the level provided when transmitting.

(l) *Symmetrical scanning*. The TO and FRO scan transmissions shall be symmetrically disposed about the mid-scan point listed in Tables 4a, 4b and 5. The mid-scan point and the center of the time interval between the TO and FRO scan shall coincide with a tolerance of plus or minus 10 microseconds.

(m) *Auxiliary data*—(1) *Addresses*. Three function identification codes are reserved to indicate transmission of Auxiliary Data A, Auxiliary Data B,

and Auxiliary Data C. Auxiliary Data A contents are specified below, Auxiliary Data B contents are reserved for future use, and Auxiliary Data C contents are reserved for national use. The address codes of the auxiliary data words shall be as shown in Table 8b.

(2) *Organization and timing.* The organization and timing of digital auxiliary data must be as specified in Table 7b. Data containing digital information must be transmitted with the least significant bit first. Alphanumeric data characters must be encoded in accordance with the 7-unit code character set as defined by the American National Standard Code for Information Interchange (ASCII). An even parity bit is added to each character. Alphanumeric data must be transmitted in the order in which they are to be read. The serial transmission of a character must be with the lower order bit transmitted first and the parity bit transmitted last. The timing for alphanumeric auxiliary data must be as shown in Table 7c.

(3) *Auxiliary Data A content:* The data items specified in Table 8c are defined as follows:

(i) *Approach azimuth antenna offset* shall represent the minimum distance between the Approach Azimuth antenna phase center and the vertical plane containing the runway centerline.

(ii) *Approach azimuth to MLS datum point distance* shall represent the minimum distance between the Approach Azimuth antenna phase center and the vertical plane perpendicular to the centerline which contains the MLS datum point.

(iii) *Approach azimuth alignment with runway centerline* shall represent the minimum angle between the approach azimuth antenna zero-degree guidance plane and the runway centerline.

(iv) *Approach azimuth antenna coordinate system* shall represent the coordinate system (planar or conical) of the angle data transmitted by the approach azimuth antenna.

(v) *Approach elevation antenna offset* shall represent the minimum distance between the elevation antenna phase center and the vertical plane containing the runway centerline.

(vi) *MLS datum point to threshold distance* shall represent the distance measured along the runway centerline from the MLS datum point to the runway threshold.

(vii) *Approach elevation antenna height* shall represent the height of the elevation antenna phase center relative to the height of the MLS datum point.

(viii) *DME offset* shall represent the minimum distance between the DME antenna phase center and the vertical plane containing the runway centerline.

(ix) *DME to MLS datum point distance* shall represent the minimum distance between the DME antenna phase center and the vertical plane perpendicular to the centerline which contains the MLS datum point.

(x) *Back azimuth antenna offset* shall represent the minimum distance between the back azimuth antenna phase center and the vertical plane containing the runway centerline.

(xi) *Back azimuth to MLS datum point distance* shall represent the minimum distance between the Back Azimuth antenna and the vertical plane perpendicular to the centerline which contains the MLS datum point.

(xii) *Back azimuth antenna alignment with runway centerline* shall represent the minimum angle between the back azimuth antenna zero-degree guidance plane and the runway centerline.

§ 171.313 Azimuth performance requirements.

This section prescribes the performance requirements for the azimuth equipment of the MLS as follows:

(a) *Approach azimuth coverage requirements.* The approach azimuth equipment must provide guidance information in at least the following volume of space (see Figure 9):

TABLE 8b—AUXILIARY DATA WORD ADDRESS CODES

No.	I ₁₃	I ₁₄	I ₁₅	I ₁₆	I ₁₇	I ₁₈	I ₁₉	I ₂₀
1.	0	0	0	0	0	1	1	1
2.	0	0	0	0	1	0	1	0
3.	0	0	0	0	1	1	0	1
4.	0	0	0	1	0	0	1	1
5.	0	0	0	1	0	1	0	0
6.	0	0	0	1	1	0	0	1
7.	0	0	0	1	1	1	1	0
8.	0	0	1	0	0	0	1	0

§ 171.313

14 CFR Ch. I (1–24 Edition)

TABLE 8b—AUXILIARY DATA WORD ADDRESS CODES—Continued

No.	I ₁₃	I ₁₄	I ₁₅	I ₁₆	I ₁₇	I ₁₈	I ₁₉	I ₂₀
9.	0	0	1	0	0	1	0	1
10.	0	0	1	0	1	0	0	0
11.	0	0	1	0	1	1	1	1
12.	0	0	1	1	0	0	0	1
13.	0	0	1	1	0	1	1	0
14.	0	0	1	1	1	0	1	1
15.	0	0	1	1	1	1	0	0
16.	0	1	0	0	0	0	1	1
17.	0	1	0	0	0	1	0	0
18.	0	1	0	0	1	0	0	1
19.	0	1	0	0	1	1	1	0
20.	0	1	0	1	0	0	0	0
21.	0	1	0	1	0	1	1	1
22.	0	1	0	1	1	0	1	0
23.	0	1	0	1	1	1	0	1
24.	0	1	1	0	0	0	0	1
25.	0	1	1	0	0	1	1	0
26.	0	1	1	0	1	0	1	1
27.	0	1	1	0	1	1	0	0
28.	0	1	1	1	0	0	1	0
29.	0	1	1	1	0	1	0	1
30.	0	1	1	1	1	0	0	0
31.	0	1	1	1	1	1	1	1
32.	1	0	0	0	0	0	1	0
33.	1	0	0	0	0	1	0	1
34.	1	0	0	0	1	0	0	0
35.	1	0	0	0	1	1	1	1
36.	1	0	0	1	0	0	0	1
37.	1	0	0	1	0	1	1	0
38.	1	0	0	1	1	0	1	1
39.	1	0	0	1	1	1	0	0
40.	1	0	1	0	0	0	0	0

TABLE 8b—AUXILIARY DATA WORD ADDRESS CODES—Continued

No.	I ₁₃	I ₁₄	I ₁₅	I ₁₆	I ₁₇	I ₁₈	I ₁₉	I ₂₀
41.	1	0	1	0	0	1	1	1
42.	1	0	1	0	1	0	1	0
43.	1	0	1	0	1	1	0	1
44.	1	0	1	1	0	0	1	1
45.	1	0	1	1	0	1	0	0
46.	1	0	1	1	1	0	0	1
47.	1	0	1	1	1	1	1	0
48.	1	1	0	0	0	0	0	1
49.	1	1	0	0	0	1	1	0
50.	1	1	0	0	1	0	1	1
51.	1	1	0	0	1	1	0	0
52.	1	1	0	1	0	0	1	0
53.	1	1	0	1	0	1	0	1
54.	1	1	0	1	1	0	0	0
55.	1	1	0	1	1	1	1	1
56.	1	1	1	0	0	0	1	1
57.	1	1	1	0	0	1	0	0
58.	1	1	1	0	1	0	0	1
59.	1	1	1	0	1	1	1	0
60.	1	1	1	1	1	0	0	0
61.	1	1	1	1	0	1	1	1
62.	1	1	1	1	1	1	0	1
63.	1	1	1	1	1	1	0	1
64.	0	0	0	0	0	0	0	0

NOTE 1: Parity bits I₁₉ and I₂₀ are chosen to satisfy the equations:
 $I_{13} + I_{14} + I_{15} + I_{16} + I_{17} + I_{18} + I_{19} = \text{EVEN}$
 $I_{14} + I_{16} + I_{18} + I_{20} = \text{EVEN}$

TABLE 8c—AUXILIARY DATA

Word (See note 6)	Data content	Type of data	Maximum time between transmissions (Seconds)	Bits used	Range of values	Least significant bit
A1	Preamble	Digital	1.0	12		
	Address			8		
	Approach azimuth antenna offset			10	–511 m to +511 m (See note 3)	1 m
	Approach azimuth to MLS datum point distance.			13	0 m to 8 191 m	1 m
	Approach azimuth antenna alignment with runway centerline.			12	–20.47° to 20.47° (See note 3)	0.01°
	Approach azimuth antenna coordinate system.			1	(See note 2)	
	Spare				13	
A2	Parity			7	(See note 1)	
	Preamble	Digital	1.0	12		
	Address			8		
	Approach elevation antenna offset			10	–511 m to +511 m (See note 3)	1 m
MLS datum point to threshold distance			10	0 m to 1 023 m	1 m	
Approach elevation antenna height			7	–6.3 m to +6.3 m (See note 3)	0.1 m	
A3	Spare			22		
	Parity			7	(See note 1)	
	Preamble	Digital	(See note 4)	12		
	Address			8		
	DME offset			8	–511 m to +511 m	1 m
DME to MLS datum point distance			14	–8 191 m to +8 191 m (See note 3).	1 m	
A4	Spare			25		
	Parity			7	(See note 1)	
	Preamble	Digital	(See note 5)	12		
	Address			8		
	Back azimuth antenna			10	–511 m to +511 m (See note 3)	1 m
Back azimuth to MLS datum point distance			11	0 m to 2 047 m	1 m	

TABLE 8C—AUXILIARY DATA—Continued

Word (See note 6)	Data content	Type of data	Maximum time between transmissions (Seconds)	Bits used	Range of values	Least significant bit
	Back azimuth antenna alignment with runway centerline.	12	-20.47° to 20.47° (See note 3) ..	0.01°
	Spare	16
	Parity	7	(See note 1)

NOTE 1: Parity bits I₇₀ to I₇₆ are chosen to satisfy the equations which follow:

For BIT I₇₀:

$$\text{Even} = (I_{13} + \dots + I_{18}) + I_{20} + I_{22} + I_{24} + I_{25} + I_{28} + I_{29} + I_{31} + I_{32} + I_{33} + I_{35} + I_{36} + I_{38} + I_{41} + I_{44} + I_{45} + I_{46} + I_{50} + (I_{52} + \dots + I_{55}) + I_{58} + I_{60} + I_{64} + I_{65} + I_{70}$$

For BIT I₇₁:

$$\text{Even} = (I_{14} + \dots + I_{19}) + I_{21} + I_{23} + I_{25} + I_{26} + I_{29} + I_{30} + I_{32} + I_{33} + I_{34} + I_{36} + I_{37} + I_{39} + I_{42} + I_{45} + I_{46} + I_{47} + I_{51} + (I_{53} + \dots + I_{56}) + I_{59} + I_{61} + I_{65} + I_{66} + I_{71}$$

For BIT I₇₂:

$$\text{Even} = (I_{15} + \dots + I_{20}) + I_{22} + I_{24} + I_{26} + I_{27} + I_{30} + I_{31} + I_{33} + I_{34} + I_{35} + I_{37} + I_{38} + I_{40} + I_{43} + I_{46} + I_{47} + I_{48} + I_{52} + (I_{54} + \dots + I_{57}) + I_{60} + I_{62} + I_{66} + I_{67} + I_{72}$$

For BIT I₇₃:

$$\text{Even} = (I_{16} + \dots + I_{21}) + I_{23} + I_{25} + I_{27} + I_{28} + I_{31} + I_{32} + I_{34} + I_{35} + I_{36} + I_{38} + I_{39} + I_{41} + I_{44} + I_{47} + I_{48} + I_{49} + I_{53} + (I_{55} + \dots + I_{58}) + I_{61} + I_{63} + I_{67} + I_{68} + I_{73}$$

For BIT I₇₄:

$$\text{Even} = (I_{17} + \dots + I_{22}) + I_{24} + I_{26} + I_{28} + I_{29} + I_{32} + I_{33} + I_{35} + I_{36} + I_{37} + I_{39} + I_{40} + I_{42} + I_{45} + I_{48} + I_{49} + I_{50} + I_{54} + (I_{56} + \dots + I_{59}) + I_{62} + I_{64} + I_{68} + I_{69} + I_{74}$$

For BIT I₇₅:

$$\text{Even} = (I_{13} + \dots + I_{17}) + I_{19} + I_{21} + I_{23} + I_{24} + I_{27} + I_{28} + I_{30} + I_{31} + I_{32} + I_{34} + I_{35} + I_{37} + I_{40} + I_{43} + I_{44} + I_{45} + I_{49} + (I_{51} + \dots + I_{54}) + I_{57} + I_{59} + I_{63} + I_{64} + I_{69} + I_{75}$$

For BIT I₇₆:

$$\text{Even} = I_{13} + I_{14} + \dots + I_{75} + I_{76}$$

NOTE 2: Code for I₅₆ is: 0 = conical; 1 = planar.

NOTE 3: The convention for the coding of negative numbers is as follows: - MSB is the sign bit; 0 = + ; 1 = - .

—Other bits represent the absolute value.

The convention for the antenna location is as follows: As viewed from the MLS approach reference datum looking toward the datum point, a positive number shall represent a location to the right of the runway centerline (lateral offset) or above the runway (vertical offset), or towards the stop end of the runway (longitudinal distance).

The convention for the antenna alignment is as follows: As viewed from above, a positive number shall represent clockwise rotation from the runway centerline to the respective zero-degree guidance plane.

NOTE 4: Data Word A3 is transmitted at intervals of 1.0 seconds or less throughout the approach Azimuth coverage sector, except when back Azimuth guidance is provided. Where back Azimuth is provided transmit at intervals of 1.33 seconds or less throughout the approach Azimuth sector and 4.0 seconds or less throughout the back Azimuth coverage sector.

NOTE 5: When back Azimuth guidance is provided, transmit at intervals of 1.33 seconds or less throughout the back Azimuth coverage sector and 4.0 seconds or less throughout the approach Azimuth coverage sector.

NOTE 6: The designation "A1" represents the function identification code for "Auxiliary Data A" and address code number 1.

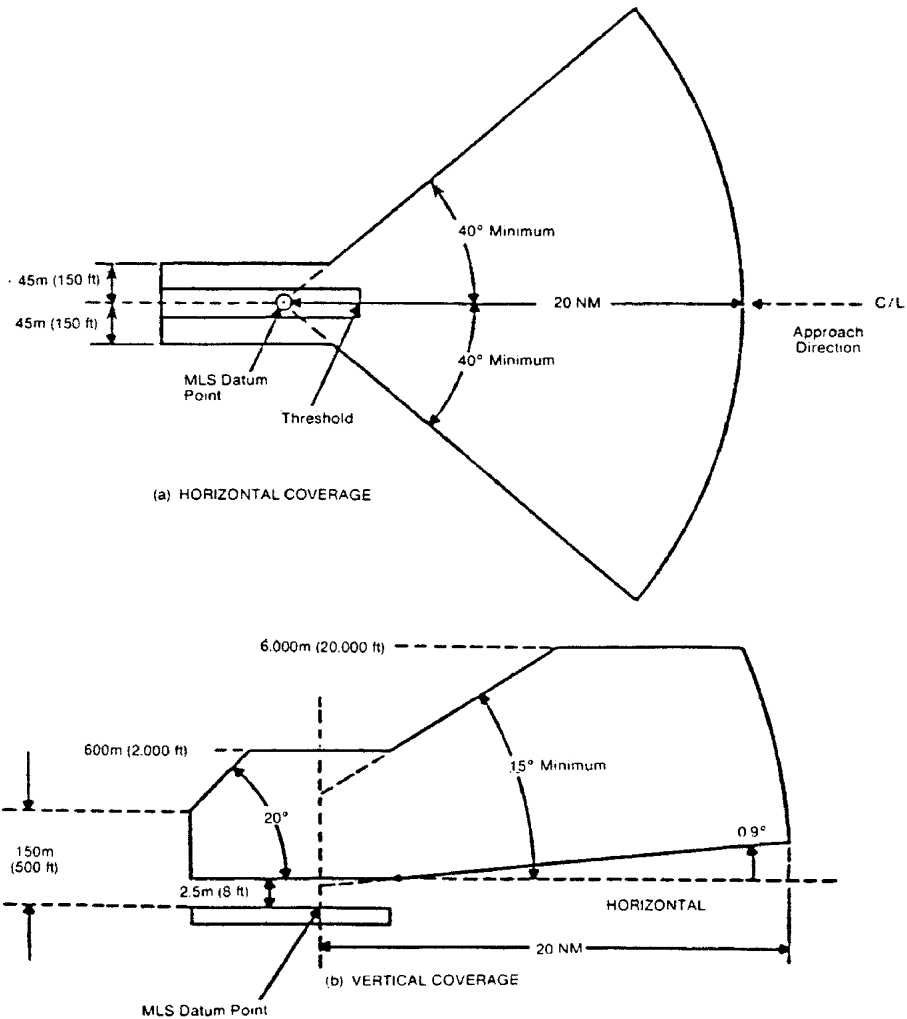

Figure 9. Approach Azimuth/Data Coverage

(1) Horizontally within a sector plus or minus 40 degrees about the runway centerline originating at the datum point and extending in the direction of the approach to 20 nautical miles from the runway threshold. The minimum proportional guidance sector must be plus or minus 10 degrees about the run-

way centerline. Clearance signals must be used to provide the balance of the required coverage, where the proportional sector is less than plus or minus 40 degrees. When intervening obstacles prevent full coverage, the $\pm 40^\circ$ guidance sector can be reduced as required. For systems providing $\pm 60^\circ$ lateral guidance

the coverage requirement is reduced to 14 nm beyond $\pm 40^\circ$.

(2) Vertically between:

(i) A conical surface originating 2.5 meters (8 feet) above the runway centerline at threshold inclined at 0.9 degree above the horizontal.

(ii) A conical surface originating at the azimuth ground equipment antenna inclined at 15 degrees above the horizontal to a height of 6,000 meters (20,000 feet).

(iii) Where intervening obstacles penetrate the lower surface, coverage need be provided only to the minimum line of sight.

(3) Runway region:

(i) Proportional guidance horizontally within a sector 45 meters (150 feet) each side of the runway centerline beginning at the stop end and extending parallel with the runway centerline in the direction of the approach to join

the approach region. This requirement does not apply to offset azimuth installations.

(ii) Vertically between a horizontal surface which is 2.5 meters (8 feet) above the farthest point of runway centerline which is in line of sight of the azimuth antenna, and in a conical surface originating at the azimuth ground equipment antenna inclined at 20 degrees above the horizontal up to a height to 600 meters (2,000 feet). This requirement does not apply to offset azimuth installations.

(4) Within the approach azimuth coverage sector defined in paragraphs (a) (1), and (2) and (3) of this section, the power densities must not be less than those shown in Table 9 but the equipment design must also allow for:

(i) Transmitter power degradation from normal by -1.5 dB;

TABLE 9—MINIMUM POWER DENSITY WITHIN COVERAGE BOUNDARIES(DBW/M²)

Function	Data signals	Angle signals for various antenna beamwidths				Clearance signals
		1°	1.5°	2°	3°	
Approach azimuth	-89.5	-88	-85.5	-82	-88
High rate approach azimuth	-89.5	-88	-88	-86.5	-88
Back azimuth	-89.5	-88	-85.5	-82	-88
Approach elevation	-89.5	-88	-88	-88

(ii) Rain loss of -2.2 dB at the longitudinal coverage extremes.

(b) *Siting requirements.* The approach azimuth antenna system must, except as allowed in paragraph (c) of this section:

(1) Be located on the extension of the centerline of the runway beyond the stop end;

(2) Be adjusted so that the zero degree azimuth plane will be a vertical plane which contains the centerline of the runway served;

(3) Have the minimum height necessary to comply with the coverage requirements prescribed in paragraph (a) of this section;

(4) Be located at a distance from the stop end of the runway that is consistent with safe obstruction clearance practices;

(5) Not obscure any light of an approach lighting system; and

(6) Be installed on frangible mounts or beyond the 300 meter (1,000 feet) light bar.

(c) On runways where limited terrain prevents the azimuth antenna from being positioned on the runway centerline extended, and the cost of the land fill or a tall tower antenna support is prohibitive, the azimuth antenna may be offset.

(d) *Antenna coordinates.* The scanning beams transmitted by the approach azimuth equipment within $\pm 40^\circ$ of the centerline may be either conical or planar.

(e) *Approach azimuth accuracy.* (1) The system and subsystem errors shall not exceed those listed in Table 10 at the approach reference datum.

At the approach reference datum, temporal sinusoidal noise components shall not exceed 0.025 degree peak in the frequency band 0.01 Hz to 1.6 Hz, and the CMN shall not exceed 0.10 degree. From the approach reference

§ 171.313

14 CFR Ch. I (1–1–24 Edition)

datum to the coverage limit, the PFE, PFN and CMN limits, expressed in angular terms, shall be allowed to linearly increase as follows:

(i) With distance along the runway centerline extended, by a factor of 1.2 for the PFE and PFN limits and to ± 0.10 degree for the CMN limits.

(ii) With azimuth angle, by a factor of 1.5 at the ± 40 degree and a factor of 2.0 at the ± 60 degree azimuth angles for the PFE, PFN and CMN limits.

(iii) With elevation angle from + 9 degrees to + 15 degrees, by a factor of 1.5 for the PFE and PFN limits.

(iv) Maximum angular limits. The PFE limits shall not exceed ± 0.25 degree in any coverage region below an elevation angle of + 9 degrees nor exceed ± 0.50 degree in any coverage region above that elevation angle. The CMN limits shall not exceed ± 0.10 degree in any coverage region within ± 10 degrees of runway centerline extended nor exceed ± 0.20 degree in any other region within coverage.

NOTE: It is desirable that the CMN not exceed ± 0.10 degree throughout the coverage.

(f) Approach azimuth antenna characteristics are as follows:

(1) *Drift.* Any azimuth angle as encoded by the scanning beam at any point within the proportional coverage must not vary more than ± 0.07 degree over the range of service conditions specified in §171.309(d) without the use of internal environmental controls. Multipath effects are excluded from this requirement.

(2) *Beam pointing errors.* The azimuth angle as encoded by the scanning beam at any point within ± 0.5 degree of the zero degree azimuth must not deviate from the true azimuth angle at that point by more than ± 0.05 degree. Multipath and drift effects are excluded from this requirement.

²The system PFN component must not exceed ± 3.5 meters (11.5 feet).

³The mean (bias) error component contributed by the ground equipment should not exceed ± 10 feet.

⁴The system control motion noise must not exceed 0.1 degree.

⁵The airborne subsystem angular errors are provided for information only.

(3) *Antenna alignment.* The antenna must be equipped with suitable optical, electrical or mechanical means or any combination of the three, to bring the zero degree azimuth radial into coincidence with the approach reference datum (for centerline siting) with a maximum error of 0.02 degree. Additionally, the azimuth antenna bias adjustment must be electronically steerable at least to the monitor limits in steps not greater than 0.005 degree.

(4) *Antenna far field patterns in the plane of scan.* On boresight, the azimuth antenna mainlobe pattern must conform to Figure 10, and the beamwidth must be such that, in the installed environment, no significant lateral reflections of the mainlobe exist along the approach course. In any case the beamwidth must not exceed three degrees. Anywhere within coverage the -3 dB width of the antenna mainlobe, while scanning normally, must not be less than 25 microseconds (0.5 degree) or greater than 250 microseconds (5 degrees). The antenna mainlobe may be allowed to broaden from the value at boresight by a factor of $1/\cos\theta$, where θ is the angle off boresight. The sidelobe levels must be as follows:

(i) *Dynamic sidelobe levels.* With the antenna scanning normally, the dynamic sidelobe level that is detected by a receiver at any point within the proportional coverage sector must be down at least 10 dB from the peak of the main beam. Outside the coverage sector, the radiation from the scanning beam antenna must be of such a nature that receiver warning will not be removed or suitable OCI signals must be provided.

(ii) *Effective sidelobe levels.* With the antenna scanning normally, the sidelobe levels in the plane of scan must be such that, in the installed environment, the CMN contributed by sidelobe reflections will not exceed the angular equivalent of 9 feet at approach reference datum over the required range of aircraft approach speeds.

TABLE 10—APPROACH AZIMUTH ACCURACIES AT THE APPROACH REFERENCE DATUM

Error type	System	Angular error (degrees)	
		Ground subsystem	Airborne subsystem
PFE	± 20 ft. (6.1m) ^{1 2}	$\pm 0.118^{\circ 3}$..	$\pm 0.017^{\circ}$
CMN	± 10.5 ft. (3.2m) ^{1 2 4}	$\pm 0.030^{\circ}$	$\pm 0.050^{\circ}$

Notes:
¹Includes errors due to ground and airborne equipment and propagation effects.

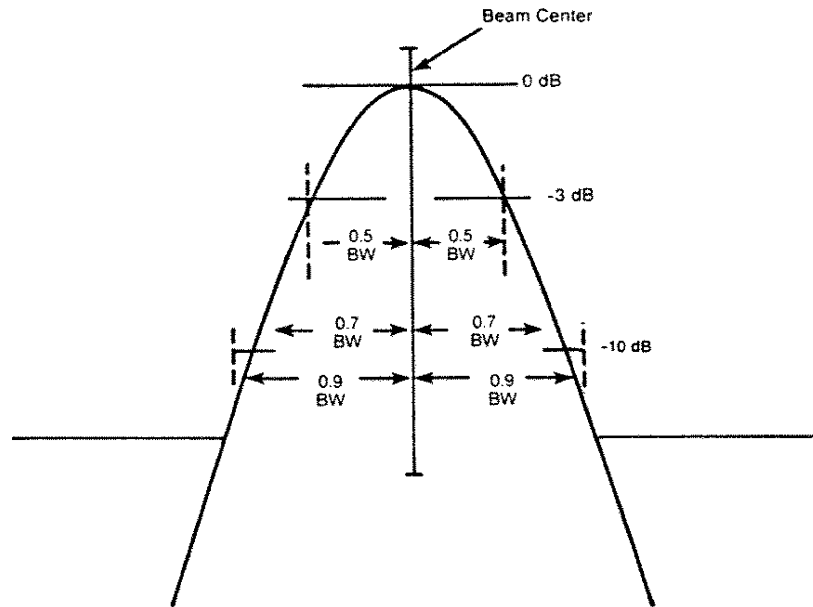

- NOTES: 1. The beam envelope is smoothed by a 26 kHz video filter before measurement.
2. BW = Beamwidth.

Figure 10. Far Field Dynamic Signal in Space

(5) *Antenna far field pattern in the vertical plane.* The azimuth antenna free space radiation pattern below the horizon must have a slope of at least -8 dB/degree at the horizon and all sidelobes below the horizon must be at least 13 dB below the pattern peak. The antenna radiation pattern above the horizon must satisfy both the system

coverage requirements and the spurious radiation requirement.

(6) *Data antenna.* The data antenna must have horizontal and vertical patterns as required for its function.

(g) *Back azimuth coverage requirements.* The back azimuth equipment where used must provide guidance information in at least the following volume of space (see Figure 11):

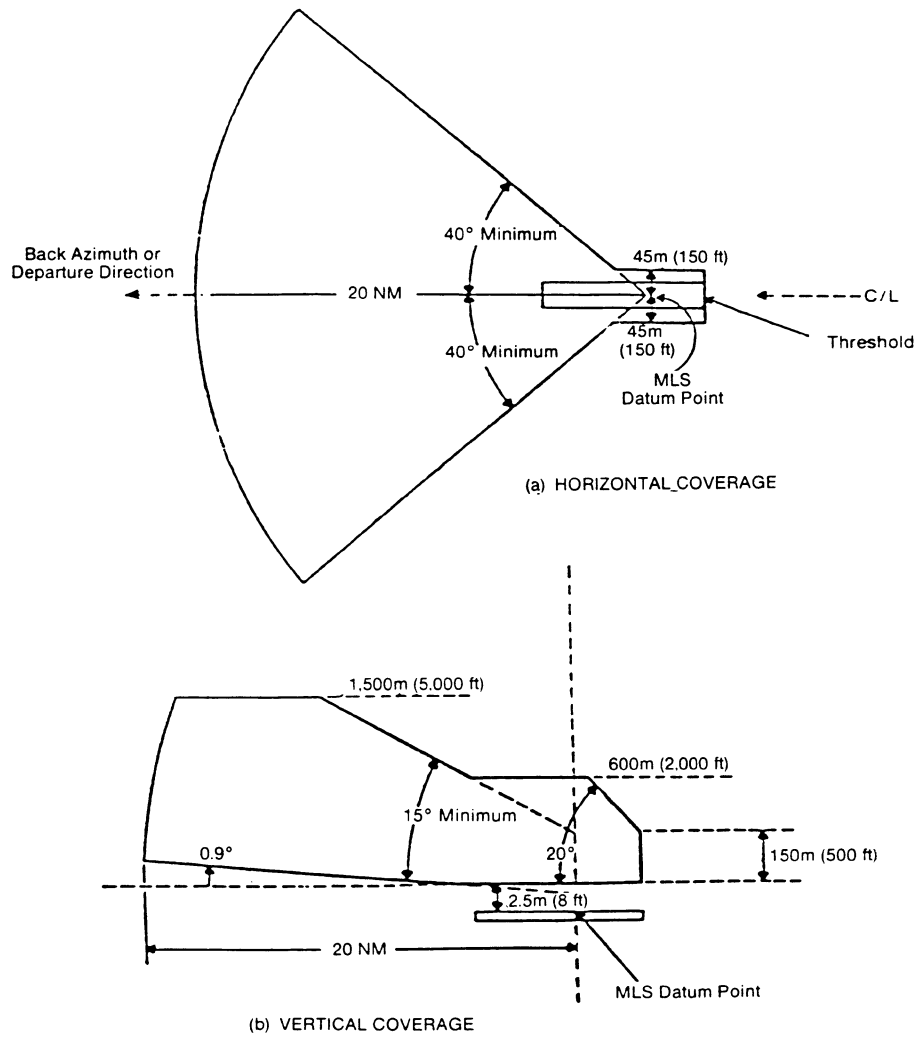

Figure 11. Back Azimuth/Data Coverage

(1) Horizontally within a sector ± 40 degrees about the runway centerline originating at the back azimuth ground equipment antenna and extending in the direction of the missed ap-

proach at least to 20 nautical miles from the runway stop end. The minimum proportional guidance sector must be ± 10 degrees about the runway centerline. Clearance signals must be

used to provide the balance of the required coverage where the proportional sector is less than ± 40 degrees.

(2) Vertically in the runway region between:

(i) A horizontal surface 2.5 meters (8 feet) above the farthest point of runway centerline which is in line of sight of the azimuth antenna, and,

(ii) A conical surface originating at the azimuth ground equipment antenna inclined at 20 degrees above the horizontal up to a height of 600 meters (2000 feet).

(3) Vertically in the back azimuth region between:

(i) A conical surface originating 2.5 meters (8 feet) above the runway stop end, included at 0.9 degree above the horizontal, and,

(ii) A conical surface originating at the missed approach azimuth ground equipment antenna, inclined at 15 degrees above the horizontal up to a height of 1500 meters (5000 feet).

(iii) Where obstacles penetrate the lower coverage limits, coverage need be provided only to minimum line of sight.

(4) Within the back azimuth coverage sector defined in paragraph (q) (1), (2), and (3) of this section the power densities must not be less than those shown in Table 9, but the equipment design must also allow for:

(i) Transmitter power degradation from normal -1.5 dB.

(ii) Rain loss of -2.2 dB at the longitudinal coverage extremes.

(h) *Back azimuth siting.* The back azimuth equipment antenna must:

(1) Normally be located on the extension of the runway centerline at the threshold end;

(2) Be adjusted so that the vertical plane containing the zero degree course line contains the back azimuth reference datum;

(3) Have minimum height necessary to comply with the course requirements prescribed in paragraph (g) of this section;

(4) Be located at a distance from the threshold end that is consistent with safe obstruction clearance practices;

(5) Not obscure any light of an approach lighting system; and

(6) Be installed on frangible mounts or beyond the 300 meter (1000 feet) light bar.

(i) *Back azimuth antenna coordinates.* The scanning beams transmitted by the back azimuth equipment may be either conical or planar.

(j) *Back azimuth accuracy.* The requirements specified in §171.313(e) apply except that the reference point is the back azimuth reference datum.

(k) *Back azimuth antenna characteristics.* The requirements specified in §171.313(f) apply.

(1) *Scanning conventions.* Figure 12 shows the approach azimuth and back azimuth scanning conventions.

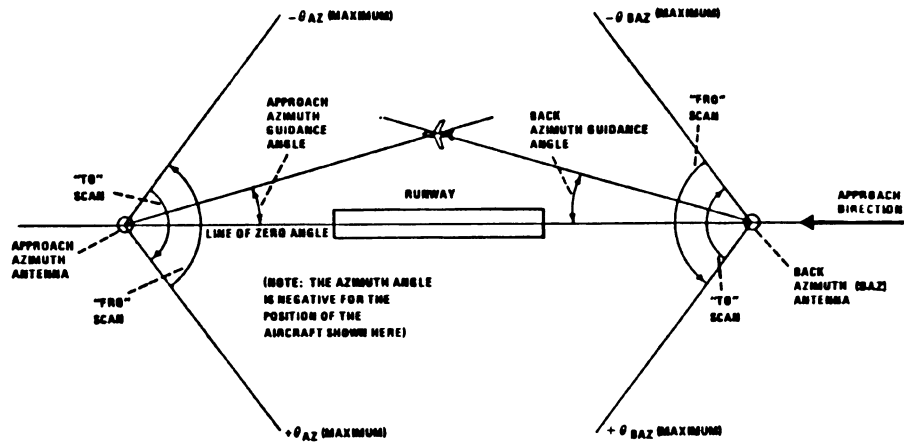

Figure 12. Azimuth Guidance Functions Scanning Conventions

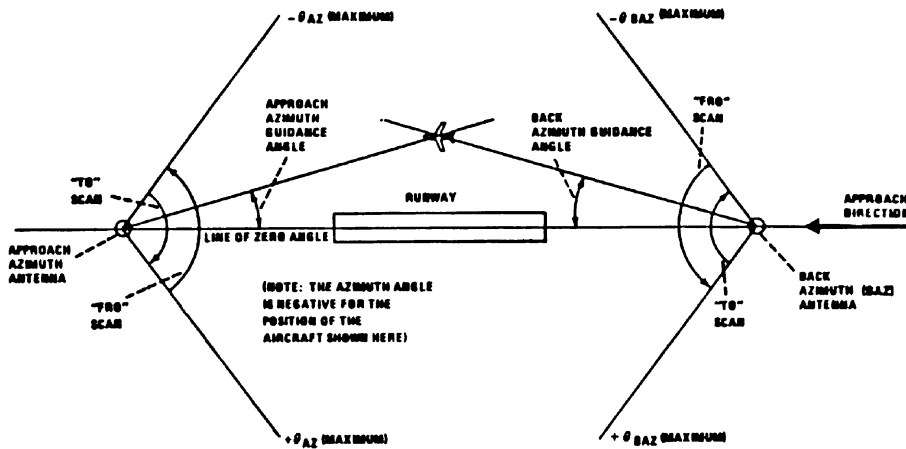

Figure 12. Azimuth Guidance Functions Scanning Conventions

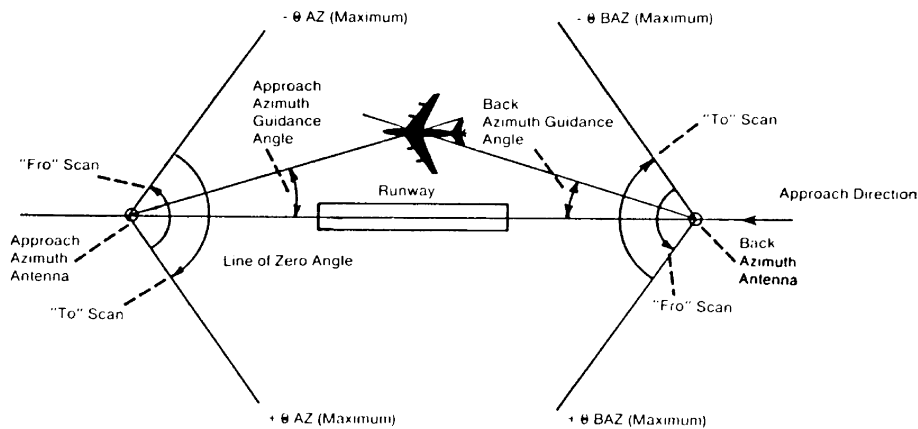

Figure 12. Azimuth Guidance Functions Scanning Conventions

(m) *False guidance.* False courses which can be acquired and tracked by an aircraft shall not exist anywhere either inside or outside of the MLS coverage sector. False courses which exist outside of the minimum coverage sector may be suppressed by the use of OCI.

NOTE: False courses may be due to (but not limited to) MLS airborne receiver acquisition of the following types of false guidance: reflections of the scanning beam, scanning beam antenna sidelobes and grating lobes, and incorrect clearance.

§ 171.315 Azimuth monitor system requirements.

(a) The approach azimuth or back azimuth monitor system must cause the radiation to cease and a warning must be provided at the designated control point if any of the following conditions persist for longer than the periods specified:

(1) There is a change in the ground equipment contribution to the mean course error component such that the path following error at the reference datum or in the direction of any azimuth radial, exceeds the limits specified in §§ 171.313(e)(1) or 171.313(j) for a period of more than one second.

NOTE: The above requirement and the requirement to limit the ground equipment mean error to ± 10 ft. can be satisfied by the following procedure. The integral monitor alarm limit should be set to the angular

equivalent of ± 10 ft. at the approach reference datum. This will limit the electrical component of the mean course error to ± 10 ft. The field monitor alarm limit should be set such that with the mean course error at the alarm limit the total allowed PFE is not exceeded on any commissioned approach course from the limit of coverage to an altitude of 100 feet.

(2) There are errors in two consecutive transmissions of Basic Data Words 1, 2, 4 or 5.

(3) There is a reduction in the radiated power to a level not less than that specified in §§ 171.313(a)(4) or 171.313(g)(4) for a period of more than one second.

(4) There is an error in the preamble DPSK transmissions which occurs more than once in any one second period.

(5) There is an error in the time division multiplex synchronization of a particular azimuth function that the requirement specified in § 171.311(e) is not satisfied and if this condition persists for more than one second.

(6) A failure of the monitor is detected.

(b) Radiation of the following functions must cease and a warning provided at the designated control point if there are errors in 2 consecutive transmissions:

- (1) Morse Code Identification,
- (2) Basic Data Words 3 and 6,
- (3) Auxiliary Data Words.

§ 171.317

14 CFR Ch. I (1-1-24 Edition)

(c) The period during which erroneous guidance information is radiated must not exceed the periods specified in §171.315(a). If the fault is not cleared within the time allowed, the ground equipment must be shut down. After shutdown, no attempt must be made to restore service until a period of 20 seconds has elapsed.

§ 171.317 Approach elevation performance requirements.

This section prescribes the performance requirements for the elevation equipment components of the MLS as follows:

(a) *Elevation coverage requirements.* The approach elevation facility must provide proportional guidance information in at least the following volume of space (see Figure 13):

(1) Laterally within a sector originating at the datum point which is at least equal to the proportional guidance sector provided by the approach azimuth ground equipment.

(2) Longitudinally from 75 meters (250 feet) from the datum point to 20 nautical miles from threshold in the direction of the approach.

(3) Vertically within the sector bounded by:

(i) A surface which is the locus of points 2.5 meters (8 feet) above the runway surface;

(ii) A conical surface originating at the datum point and inclined 0.9 degree above the horizontal and,

(iii) A conical surface originating at the datum point and inclined at 15.0 degrees above the horizontal up to a height of 6000 meters (20,000 feet).

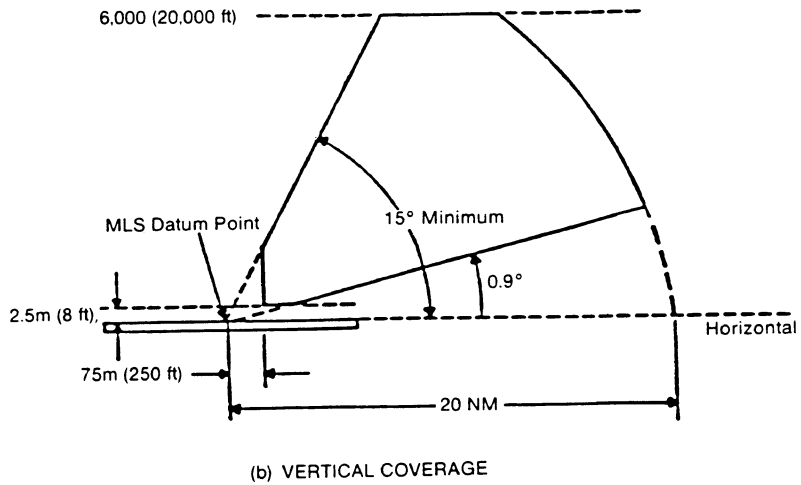
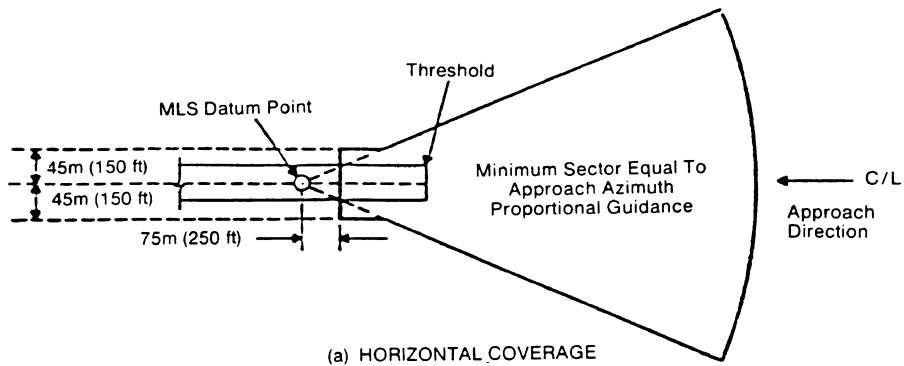

Figure 13. Approach Elevation Coverage

Where the physical characteristics of the approach region prevent the achievement of the standards under paragraphs (a) (1), (2), and (3) of this

section, guidance need not be provided below a conical surface originating at the elevation antenna and inclined 0.9 degree above the line of sight.

§ 171.317

14 CFR Ch. I (1–1–24 Edition)

(4) Within the elevation coverage sector defined in paragraphs (a) (1), (2) and (3) of this section, the power densities must not be less than those shown in Table 9, but the equipment design must also allow for:

(i) Transmitter power degradation from normal by -1.5 dB.

(ii) Rain loss of -2.2 dB at the coverage extremes.

(b) *Elevation siting requirements.* The Elevation Antenna System must:

(1) Be located as close to runway centerline as possible (without violating obstacle clearance criteria).

(2) Be located near runway threshold such that the asymptote of the minimum glidepath crosses the threshold of the runway at the Approach Reference Datum height. Normally, the minimum glidepath should be 3 degrees and the Approach Reference Datum height should be 50 feet. However, there are circumstances where other glideslopes and reference datum heights are appropriate. Some of these instances are discussed in FAA Order 8260.34 (Glide Slope Threshold Crossing Height Requirements) and Order 8260.3 (IFR Approval of MLS.)

(3) Be located such that the MLS Approach Reference Datum and ILS Reference Datum heights are coincident within a tolerance of 3 feet when MLS is installed on a runway already served by an ILS. This requirement applies only if the ILS glide slope is sited such that the height of the reference datum meets the requirements of FAA Order 8260.34.

(c) *Antenna coordinates.* The scanning beams transmitted by the elevation subsystem must be conical.

(d) *Elevation accuracy.* (1) The accuracies shown in Table 13 are required at the approach reference datum. From the approach reference datum to the coverage limit, the PFE, PFN and CMN limits shall be allowed to linearly increase as follows:

(i) With distance along the runway centerline extended at the minimum glide path angle, by a factor of 1.2 for the PFE and PFN limits and to ±0.10 degree for the CMN limits;

(ii) With azimuth angle, from runway centerline extended to the coverage extreme, by a factor of 1.2 for the PFE

and PFN limits and by a factor of 2.0 for the CMN limits;

(iii) With increasing elevation angles from + 3 degrees to + 15 degrees, by a factor of 2.0 for the PFE and PFN limits;

TABLE 13—ELEVATION ACCURACIES AT THE APPROACH REFERENCE DATUM

Error type	System	Angular error (degrees)	
		Ground subsystem	Airborne subsystem ⁴
PFE	¹ 2 ±0.133	(³)	±0.017
CMN	¹ ±0.050	±0.020	±0.010

Notes:

¹ Includes errors due to ground and airborne equipment and propagation effects.

² The system PFN component must not exceed ±0.087 degree.

³ The mean (bias) error component contributed by the ground equipment should not exceed ±0.067 degree.

⁴ The airborne subsystem angular errors are provided for information only.

(iv) With decreasing elevation angle from + 3 degrees (or 60% of the minimum glide path angle, whichever is less) to the coverage extreme, by a factor of 3 for the PFE, PFN and CMN limits; and

(v) Maximum angular limits. the CMN limits shall not exceed ±0.10 degree in any coverage region within ±10 degrees laterally of runway centerline extended which is above the elevation angle specified in (iv) above.

NOTE: It is desirable that the CMN not exceed ±0.10 degree throughout the coverage region above the elevation angle specified in paragraph (d)(1)(iv) of this section.

(2) The system and ground subsystem accuracies shown in Table 13 are to be demonstrated at commissioning as maximum error limits. Subsequent to commissioning, the accuracies are to be considered at 95% probability limits.

(e) Elevation antenna characteristics are as follows:

(1) *Drift.* Any elevation angle as encoded by the scanning beam at any point within the coverage sector must not vary more than 0.04 degree over the range of service conditions specified in §171.309(d) without the use of internal environmental controls. Multipath effects are excluded from this requirement.

(2) *Beam pointing errors.* The elevation angle as encoded by the scanning beam at any point within the coverage sector

must not deviate from the true elevation angle at that point by more than ± 0.04 degree for elevation angles from 2.5° to 3.5° . Above 3.5° these errors may linearly increase to ± 0.1 degree at 7.5° . Multipath and drift effects are excluded from this requirement.

(3) *Antenna alignment.* The antenna must be equipped with suitable optical, electrical, or mechanical means or any combination of the three, to align the lowest operationally required glidepath to the true glidepath angle with a maximum error of 0.01 degree. Additionally, the elevation antenna bias adjustment must be electronically steerable at least to the monitor limits in steps not greater than 0.005 degrees.

(4) *Antenna far field patterns in the plane of scan.* On the lowest operationally required glidepath, the antenna mainlobe pattern must conform to Figure 10, and the beamwidth must be such that in the installed environment, no significant ground reflections of the mainlobe exist. In any case, the beamwidth must not exceed 2 degrees. The antenna mainlobe may be allowed to broaden from the value at boresight by a factor of $1/\cos\theta$, where θ is the angle of boresight. Anywhere within coverage, the -3 dB width of the antenna mainlobe, while scanning normally, must not be less than 25 microseconds (0.5 degrees) or greater than 250 microseconds (5 degrees). The sidelobe levels must be as follows:

(i) *Dynamic sidelobe levels.* With the antenna scanning normally, the dynamic sidelobe level that is detected by a receiver at any point within the proportional coverage sector must be down at least 10 dB from the peak of the mainlobe. Outside the proportional coverage sector, the radiation from the scanning beam antenna must be of such a nature that receiver warnings will not be removed or a suitable OCI signal must be provided.

(ii) *Effective sidelobe levels.* With the antenna scanning normally, the sidelobe levels in the plane of scan must be such that, when reflected from the ground, the resultant PFE along any glidepath does not exceed 0.083 degrees.

(5) *Antenna far field pattern in the horizontal plane.* The horizontal pattern of the antenna must gradually de-empha-

size the signal away from antenna boresight. Typically, the horizontal pattern should be reduced by at least 3 dB at 20 degrees off boresight and by at least 6 dB at 40 degrees off boresight. Depending on the actual multipath conditions, the horizontal radiation patterns may require more or less de-emphasis.

(6) *Data antenna.* The data antenna must have horizontal and vertical patterns as required for its function.

(f) *False guidance.* False courses which can be acquired and tracked by an aircraft shall not exist anywhere either inside or outside of the MLS coverage sector. False courses which exist outside of the minimum coverage sector may be suppressed by the use of OCI.

NOTE: False courses may be due to (but not limited to) MLS airborne receiver acquisition of the following types of false guidance: reflections of the scanning beam and scanning beam antenna sidelobes and grating lobes.

§ 171.319 Approach elevation monitor system requirements.

(a) The monitor system must act to ensure that any of the following conditions do not persist for longer than the periods specified when:

(1) There is a change in the ground component contribution to the mean glidepath error component such that the path following error on any glidepath exceeds the limits specified in § 171.317(d) for a period of more than one second.

NOTE: The above requirement and the requirement to limit the ground equipment mean error to ± 0.067 degree can be satisfied by the following procedure. The integral monitor alarm limit should be set to ± 0.067 degree. This will limit the electrical component of mean glidepath error to ± 0.067 degree. The field monitor alarm limit should be set such that with the mean glidepath error at the alarm limit the total allowed PFE is not exceeded on any commissioned glidepath from the limit of coverage to an altitude of 100 feet.

(2) There is a reduction in the radiated power to a level not less than that specified in § 171.317(a)(4) for a period of more than one second.

(3) There is an error in the preamble DPSK transmission which occurs more than once in any one second period.

§ 171.321

(4) There is an error in the time division multiplex synchronization of a particular elevation function such that the requirement specified in §171.311(e) is not satisfied and this condition persists for more than one second.

(5) A failure of the monitor is detected.

(b) The period during which erroneous guidance information is radiated must not exceed the periods specified in §171.319(a). If the fault is not cleared within the time allowed, radiation shall cease. After shutdown, no attempt must be made to restore service until a period of 20 seconds has elapsed.

§ 171.321 DME and marker beacon performance requirements.

(a) The DME equipment must meet the performance requirements prescribed in subpart G of the part. This subpart imposes requirements that performance features must comply with International Standards and Recommended Practices, Aeronautical Telecommunications, Vol. I of Annex 10 to ICAO. It is available from ICAO, Aviation Building, 1080 University Street, Montreal 101, Quebec, Canada. Attention: Distribution Officer and also available for inspection at the National Archives and Records Administration (NARA). For information on the availability of this material at NARA, call 202-741-6030, or go to: http://www.archives.gov/federal_register/code_of_federal_regulations/ibr_locations.html.

(b) MLS marker beacon equipment must meet the performance requirements prescribed in subpart H of this part. This subpart imposes requirements that performance features must comply with International Standards and Recommended Practices, Aeronautical Telecommunications, Vol. I of Annex 10 to ICAO.

[Doc. No. 5034, 29 FR 11337, Aug. 6, 1964, as amended at 69 FR 18803, Apr. 9, 2004]

§ 171.323 Fabrication and installation requirements.

(a) The MLS facility must be permanent and must be located, constructed, and installed in accordance with best commercial engineering practices, using applicable electric and safety codes and Federal Communications

14 CFR Ch. I (1-1-24 Edition)

Commission (FCC) licensing requirements and siting requirements of §§171.313(b) and 171.317(b).

(b) The MLS facility components must utilize solid state technology except that traveling wave tube amplifiers (TWTA) may be used. A maximum level of common modularity must be provided along with diagnostics to facilitate maintenance and troubleshooting.

(c) An approved monitoring capability must be provided which indicates the status of the equipment at the site and at a remotely located maintenance area, with monitor capability that provides pre-alarm of impending system failures. This monitoring feature must be capable of transmitting the status and pre-alarm over standard phone lines to a remote section. In the event the sponsor requests the FAA to assume ownership of the facility, the monitoring feature must also be capable of interfacing with FAA remote monitoring requirements. This requirement may be complied with by the addition of optional software and/or hardware in space provided in the original equipment.

(d) The mean corrective maintenance time of the MLS equipment must be equal to or less than 0.5 hours with a maximum corrective maintenance time not to exceed 1.5 hours. This measure applies to correction of unscheduled failures of the monitor, transmitter and associated antenna assemblies, limited to unscheduled outage and out of tolerance conditions.

(e) The mean-time-between-failures of the MLS angle system must not be less than 1,500 hours. This measure applies to unscheduled outage, out-of-tolerance conditions, and failures of the monitor, transmitter, and associated antenna assemblies.

(f) The MLS facility must have a reliable source of suitable primary power, either from a power distribution system or locally generated. Adequate power capacity must be provided for the operation of the MLS as well as the test and working equipment of the MLS.

(g) The MLS facility must have a continuously engaged or floating battery power source for the continued normal operation of the ground station

operation if the primary power fails. A trickle charge must be supplied to recharge the batteries during the period of available primary power. Upon loss and subsequent restoration of power, the battery must be restored to full charge within 24 hours. When primary power is applied, the state of the battery charge must not affect the operation of the MLS ground station. The battery must allow continuation of normal operation of the MLS facility for at least 2 hours without the use of additional sources of power. When the system is operating from the battery supply without prime power, the radome deicers and the environmental system need not operate. The equipment must meet all specification requirements with or without batteries installed.

(h) There must be a means for determining, from the ground, the performance of the system including antenna, both initially and periodically.

(i) The facility must have, or be supplemented by, ground, air, or landline communications services. At facilities within or immediately adjacent to controlled airspace, that are intended for use as instrument approach aids for an airport, there must be ground air communications or reliable communications (at least a landline telephone) from the airport to the nearest FAA air traffic control or communication facility. Compliance with this paragraph need not be shown at airports where an adjacent FAA facility can communicate with aircraft on the ground at the airport and during the entire proposed instrument approach procedure. In addition, at low traffic density airports within or immediately adjacent to controlled airspace, and where extensive delays are not a factor, the requirements of this paragraph may be reduced to reliable communications from the airport to the nearest FAA air traffic control or communications facility. If the adjacent FAA facility can communicate with aircraft during the proposed instrument approach procedure down to the airport surface or at least down to the minimum en route altitude, this would require at least a landline telephone.

(j) The location of the phase center for all antennas must be clearly marked on the antenna enclosures.

(k) The latitude, longitude and mean sea level elevation of all MLS antennas, runway threshold and runway stop end must be determined by survey with an accuracy of ± 3 meters (± 10 feet) laterally and ± 0.3 meter (± 1.0 foot) vertically. The relative lateral and vertical offsets of all antenna phase centers, and both runway ends must be determined with an accuracy of ± 0.3 meter (± 1.0 foot) laterally and ± 0.03 meter (± 0.1 foot) vertically. The owner must bear all costs of the survey. The results of this survey must be included in the "operations and maintenance" manual required by section 171.325 of this subpart and will be noted on FAA Form 198 required by § 171.327.

[Doc. No. 20669, 51 FR 33177, Sept. 18, 1986, as amended by Amdt. 171-16, 56 FR 65665, Dec. 17, 1991]

§ 171.325 Maintenance and operations requirements.

(a) The owner of the facility must establish an adequate maintenance system and provide MLS qualified maintenance personnel to maintain the facility at the level attained at the time it was commissioned. Each person who maintains a facility must meet the FCC licensing requirements and demonstrate that he has the special knowledge and skills needed to maintain an MLS facility, including proficiency in maintenance procedures and the use of specialized test equipment.

(b) In the event of out-of-tolerance conditions or malfunctions, as evidenced by receiving two successive pilot reports, the owner must close the facility by encasing radiation, and issue a "Notice to Airmen" (NOTAM) that the facility is out of service.

(c) The owner must prepare, and obtain approval of, an operations and maintenance manual that sets forth mandatory procedures for operations, periodic maintenance, and emergency maintenance, including instructions on each of the following:

- (1) Physical security of the facility.
- (2) Maintenance and operations by authorized persons.
- (3) FCC licensing requirements for operations and maintenance personnel.

§ 171.325

14 CFR Ch. I (1–1–24 Edition)

- (4) Posting of licenses and signs.
- (5) Relations between the facility and FAA air traffic control facilities, with a description of the boundaries of controlled airspace over or near the facility, instructions for relaying air traffic control instructions and information, if applicable, and instructions for the operation of an air traffic advisory service if the facility is located outside of controlled airspace.
- (6) Notice to the Administrator of any suspension of service.
- (7) Detailed and specific maintenance procedures and servicing guides stating the frequency of servicing.
- (8) Air-ground communications, if provided, expressly written or incorporating appropriate sections of FAA manuals by reference.
- (9) Keeping the station logs and other technical reports, and the submission of reports required by § 171.327.
- (10) Monitoring of the MLS facility.
- (11) Inspections by United States personnel.
- (12) Names, addresses, and telephone numbers of persons to be notified in an emergency.
- (13) Shutdowns for periodic maintenance and issuing of NOTAM for routine or emergency shutdowns.
- (14) Commissioning of the MLS facility.
- (15) An acceptable procedure for amending or revising the manual.
- (16) An explanation of the kinds of activities (such as construction or grading) in the vicinity of the MLS facility that may require shutdown or recertification of the MLS facility by FAA flight check.
- (17) Procedures for conducting a ground check of the azimuth and elevation alignment.
- (18) The following information concerning the MLS facility:
 - (i) Facility component locations with respect to airport layout, instrument runways, and similar areas.
 - (ii) The type, make and model of the basic radio equipment that provides the service including required test equipment.
 - (iii) The station power emission, channel, and frequency of the azimuth, elevation, DME, marker beacon, and associated compass locators, if any.
 - (iv) The hours of operation.
 - (v) Station identification call letters and method of station identification and the time spacing of the identification.
 - (vi) A description of the critical parts that may not be changed, adjusted, or repaired without an FAA flight check to confirm published operations.
- (d) The owner or his maintenance representative must make a ground check of the MLS facility periodically in accordance with procedures approved by the FAA at the time of commissioning, and must report the results of the checks as provided in § 171.327.
- (e) The only modifications permitted are those that are submitted to FAA for approval by the MLS equipment manufacturer. The owner or sponsor of the facility must incorporate these modifications in the MLS equipment. Associated changes must also be made to the operations and maintenance manual required in paragraph (c) of this section. This and all other corrections and additions to this operations and maintenance manual must also be submitted to FAA for approval.
- (f) The owner or the owner's maintenance representative must participate in inspections made by the FAA.
- (g) The owner must ensure the availability of a sufficient stock of spare parts, including solid state components, or modules to make possible the prompt replacement of components or modules that fail or deteriorate in service.
- (h) FAA approved test instruments must be used for maintenance of the MLS facility.
- (i) Inspection consists of an examination of the MLS equipment to ensure that unsafe operating conditions do not exist.
- (j) Monitoring of the MLS radiated signal must ensure a high degree of integrity and minimize the requirements for ground and flight inspection. The monitor must be checked daily during the in-service test evaluation period (96 hour burn in) for calibration and stability. These tests and ground checks or azimuth, elevation, DME, and marker beacon radiation characteristics must be conducted in accordance with the maintenance requirements of this section.

§ 171.327 Operational records.

The owner of the MLS facility or his maintenance representative must submit the following operational records at the indicated time to the appropriate FAA regional office where the facility is located.

(a) *Facility Equipment Performance & Adjustment Data (FAA Form 198)*. The FAA Form 198 shall be filled out by the owner or his maintenance representative with the equipment adjustments and meter readings as of the time of facility commissioning. One copy must be kept in the permanent records of the facility and two copies must be sent to the appropriate FAA regional office. The owner or his maintenance representative must revise the FAA Form 198 data after any major repair, modernization, or retuning to reflect an accurate record of facility operation and adjustment.

(b) *Facility Maintenance Log (FAA Form 6030-1)*. FAA Form 6030-1 is permanent record of all the activities required to maintain the MLS facility. The entries must include all malfunctions met in maintaining the facility including information on the kind of

work and adjustments made, equipment failures, causes (if determined) and corrective action taken. In addition, the entries must include completion of periodic maintenance required to maintain the facility. The owner or his maintenance representative must keep the original of each form at the facility and send a copy to the appropriate FAA regional office at the end of each month in which it is prepared. However, where an FAA approved remote monitoring system is installed which precludes the need for periodic maintenance visits to the facility, monthly reports from the remote monitoring system control point must be forwarded to the appropriate FAA regional office, and a hard copy retained at the control point.

(c) *Technical Performance Record (FAA Form 6830 (formerly FAA Form 418))*. This form contains a record of system parameters as specified in the manufacturer's equipment manual. This data will be recorded on each scheduled visit to the facility. The owner or his maintenance representative shall keep the original of each record at the facility and send a copy of the form to the appropriate FAA regional office.